

# JED T430/T440 Projector Controller user's manual version V165P part B

(Ed Schoell 31<sup>st</sup> July 2024... Projector control selected)

Table of Contents			
Acer projector family	1	NEC Projector	30
BenQ MP5/7xx, SP820,Opt. Gr3	4	Optoma Projector Gr.1,2,4,5	33
Canon	9	Panasonic Projector	37
Casio XJ-M	10	Plus: U5, U7	40
Christie series	12	ProjectionDesign & Christie	41
Dell	13	Promethean PRM-10, 20A	42
Eiki XDP-3500, XIP-2600	14	Ricoh	43
Epson VP21, IR to S/W/X5...	15	Sharp	44
HP projector	19	Smart projector	45
Hitachi proj	20		
InFocus / ASK Proxima	23		
Mitsubishi	27		
			Note: Sanyo/Eiki deleted from V1.62 onwards.
			46
			49
			51
			54
			58
			60

## Setting T430/T440 systems to control a Projector or LCD device

The default setting is for Projectors

**Note: When a unit is re-loaded with a new firmware file, the unit is reset to a "PROJECTOR" setting.**

- To set the T430/T440 for **projector** control, set DF on the rotary switches SW2 and SW3 and turn off all option switches.  
Push the Reset button and the green LED blinks for 2 seconds;
- To set the T430/T440 for **LCD** control, set DF on the rotary switches SW2 and SW3, and turn ON Option SW8 only.  
Push the Reset button and the green LED blinks for 2 seconds

**The device is now ready to be set to a code and option setting. Don't forget to press the RESET switch again.**

## Acer (**Code 70, DVI-I, Code 71, HDMI at 9600, Code 72, DVI-I, Code 73, HDMI at 115200 baud**)

There are many Acer projectors covered by this driver ... all use common codes, but vary as to sources supported. Drivers 70 and 72 support DVI-D and DVI-A as video 2, Computer 2, and 71 and 72 support HDMI. Baud rates of 9600 are supported by codes 70 and 71, and 115200 by code 72 and 73. Some have RGB2, but no codes for this source are published (Most RGB2 is actually via a DVI-A interface, it seems).

Acer projectors are shown in groups which have similar properties and protocol ... HDMI at the front of a group indicates that group as an HDMI interface rather than DVI, and so codes 71 and 73 should be used for these. As for baud rate, initially models shown below in **bold** are 115200 bps, but several manuals show that during production of a particular model, the baud rate changed to 9600. The best option is to try 9600 settings first (codes 70 and 71) and if that does not work, try at 115200 (codes 72 and 73.)

A: HDMI **S5200**, S5201/B, **P5205**, P5206, S5201/B, P5301/WB, P5270, P5271/i, P5290/W, P5390W, P7201, P7209, P7270i, P7280

B: HDMI P1100/C, P1200/i/B/C/n, P1201B, P1203, P1206, P1303

C: M114, M112

D: HDMI **115200 X1110, X1210, X1210S/K, X1213**, D315, **S21T**, D302, X1111/H/A, X1211/H/S/K, X1213P/PH, X1311KW, X1313PW/PWH

E: X1161/A/N, X1261, X110, **H5360**, D110

F: HDMI P7200, P7203, P7205, P7500

G: HDMI **115200 X1130P/PS, X1120PK, X1230S/PK/PS, X1235, X1237**

H: HDMI H7530, H7531

I: HDMI X1120, X1220H, X1320WH

J: HDMI H9500/BD

K: DVI:XD1170, DVI:XD1270, XD1280

Channel codes are:

Input1 := '\* 0 IR 015' + 0D; //Computer1 RGB analog-RGB VGA DB9/1  
Input2 := '\* 0 IR 028' + 0D; //Computer2 RGB analog- via DVI-A or DB9/2  
  
Input3 := '\* 0 IR 019' + 0D; //Video1 Comp Video  
Input4 := '\* 0 IR 016' + 0D; //Video2 DVI-D (**Codes 70, 72**) Use **OPT1 On for DVI-D for main video.**

**or**

Input4 := '\* 0 IR 050' + 0D; //Video2 HDMI (**Codes 71, 73**) Use **OPT1 On for HDMI for main video.**

\* T440: OPT6 switch ON will use S-Video in place of HDMI/DVI. T430: Uses HDMI for Video2

Input5 := '\* 0 IR 017' + 0D; // Component YPbPr via DB15 HDTV  
Input6 := '\* 0 IR 029' + 0D; // Component YPbPr DVI or HDMI via adaptor

Any one of these codes can be set into Constant:0/Constant:1 for computer codes and Constant:2/Constant:3 for video codes. (The default is to have Computer1 (above) as the “Computer” channel and Video1 as the “Video” channel. Setting OPT1 switch ON will swap Video1 and Video2 channels, making S-Video the video default. Setting OPT5 will swap Computer1 and Computer2. Setting OPT4 will allow double- presses on some keyboards.).

- Power on projector connection blink codes available;
- OPT7 handshake mode not available;
- Source lock must be turned ON in the “Maintenance” menu;
- Freeze and mute are toggle mode only in these projectors, so 2-yellow-button mute mode is NOT supported;
- Audio functions are limited to one (sometimes two) audio input(s) and no output to room speakers on most. Use a T441/T461 if audio control is needed;
- The Volume level indication bar does NOT appear on the projected image screen UNLESS a valid video/VGA/HDMI image is being shown at the time. Commands are ignored;
- Volume processing time is 600ms per increment via RS232, and we have provided auto-incrementing to the Volume Up and Volume Down buttons, but it takes 1 minute (100 x 600ms) to ramp from 0 to 100 audio level.

### RS232 connections to 3-Pin DIN Acer projectors

(Note some seem to have DB9 connector. Use a multimeter to determine the connections ... -5 to -9 volts indicates the projector Tx output, and the other pin (of 2 & 3) is the T440/T430 Tx input to the projector).

Mini-DIN 3 socket on projector. Comms at: 9600 DP8N1 or at 115,200.

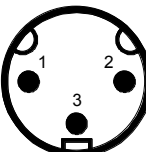
Function/Direction	T440 “projector” Connection	Acer Serial Port Connector	 Mini-DIN 3
Ground	Ground	Mini-DIN 3 pin 3 (Gnd)	
Data from T440 to projector	Tx	Mini-DIN 3 pin 1 or 2 (RXD)	
Reply data from projector to T440	Rx	Mini-DIN 3 pin 2 or 1 (TXD)	

After installation wiring of any projector to a T440, use a multimeter to check voltages of -9 on BOTH TX and RX pins in any installation, as described in the troubleshooting part of this manual.

## BARCO G60 (Code 16)

(Google G60 R5910887\_01 BARCO to obtain a manual.)

Channel codes are:

```
Input1 := '[MSRC0]'; //Computer1 VGA
Input2 := '[MSRC2]'; //Computer2 HDMI 2
Input3 := '[MSRC1]'; //Video1 HDMI 1
Input4 := '[MSRC4]'; //Video2 HDBaseT
Input5 := '[MSRC3]'; //DVI
Input6 := '[MSRC5]'; //3G-SDI
```

Any one of these codes can be set into Constant:0/Constant:1 for computer codes and Constant:2/Constant:3 for video codes. (The default is to have Computer1 (above) as the “Computer” channel and Video1 as the “Video” channel. Setting OPT1 switch ON will swap Video1 and Video2 channels. Setting OPT5 will swap Computer1 and Computer2. Setting OPT4 will allow double-presses on some keyboards.).

- No handshake mode or power on panel connection blink codes available;
- No audio is provided ... this is an installation projector used with external audio systems. T460 could be used with a code 9 keyboard, but Freeze and picture blank codes are supported, so a Code A keyboard works well with this model

**(At this point JED does not have serial port wiring information (The I/O port diagram on page 11 of the G60 manual shows the RS232 port is a D9 connector of some sort.)**

After installation wiring of any projector to a T440, use a multimeter to check voltages of -9 on BOTH TX and RX pins in any installation, as described in the troubleshooting part of this manual.

## BenQ SH960 (Code 3D)

Channel codes for this is:

```

Input1 := '*sour=RGB#';           // Computer1 Analog RGB DB15
Input2 := '*sour=yprbr#';        // Component RGB via RCA

Input3 := '*sour=vid#';          // Video1 Composite Video RCA * (OPT1 swaps Video1 & Video2)
Input4 := '*sour=hdmi#';        // Video2 HDMI * (OPT1 swaps Video1 & Video2)
or
Input4 := '*sour=svid#';         //Video2 S-Video
  
```

\* T440: OPT6 switch ON will use S-Video in place of HDMI. T430: uses HDMI as Video 2.

```

Input5 := '*sour=RGB2#';         // Component via DB15
  
```

Any one of these codes can be set into Constant:0/Constant:1 for computer codes and Constant:2/Constant:3 for video codes. (The default is to have Computer1 (above) as the “Computer” channel and Video1 as the “Video” channel. Setting OPT1 switch ON will swap Video1 and Video2 channels, making HDMI the video default. Setting OPT5 will swap Computer1 and Computer2. Setting OPT4 will allow double- presses on some keyboards.).

OPT7 handshake mode not available;

- Power on panel connection blink codes available;
- In System Setup: “Auto Power Off” -> “Disable, “Sleep Time” -> Disable, “Quick Auto Search” -> Off;
- In Advanced Setup: In Lan Control Settings -> Control by RS232;
- In Advanced Setup: In Baud rate -> 19200;
- In Advanced Setup: Direct Power On -> Set OFF, Direct Power Off -> Set OFF
- Audio functions are limited to one audio input and no output. Use a T441/T461 if audio control is needed.

## SP870( Rev 2.13) (Code 37 )

```

Input1 := 0D + '*sour=rgb#' + 0D //Computer1 Analog RGB DB15
Input2 := 0D + '*sour=dvid#' + 0D; //Computer2 DVI-D (Digital)

Input3 := 0D + '*sour=vid#' + 0D; //Video1 Composite Video RCA (OPT1 swaps Video1 & Video2)
Input4 := 0D + '*sour=dvid#' + 0D; //Video 2 DVI-D (Digital)* (OPT1 swaps Video1 & Video2)
  
```

\* T440: OPT6 switch ON will use S-Video in place of HDMI/DVI. T430: Uses DVI-D as Video2

```

Input4 := 0D + '*sour=svid#' + 0D; //Video2 S-Video*

Input5 := 0D + '*sour=yprbr#' + 0D; // Component
Input6 := 0D + '*sour=dvid#' + 0D; // DVI-D (Digital)
  
```

## BenQ projectors: RS232 Connection: lots, inc. SH960, MP722, MP723, MP771, SP870, SP920

(Communications runs at 19200 8N1. Projectors use a male 8-pin mini-DIN on the cable)

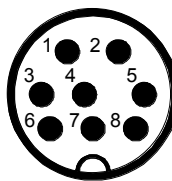
Function	T440 “projector” Connection	DIN 8-pin BenQ,	
Ground	Pin 1	Pin 4	 <p>Mini DIN 8</p>
Serial TX out to projector	Pin 2	Pin 1	
Serial RX into T440 from proj.	Pin 3	Pin 7	
CTS out to projector	Pin 4	Not used	

After installation wiring of any projector to a T440, use a multimeter to check voltages of -9 on BOTH TX and RX pins in any installation, as described in the troubleshooting part of this manual.

## BenQ MP724, MP727, MP735 (Code 3E )

Channel codes for these are:

```

Input1 := 0D + '*sour=RGB#' + 0D; //Computer1 Analog RGB DB15
Input2 := 0D + '*sour=dviA#' + 0D; //Computer2 DVI-A (Analog)

Input3 := 0D + '*sour=vid#' + 0D; //Video1 Composite Video RCA (OPT1 swaps Video1 & Video2)
Input4 := 0D + '*sour=hdmi #' + 0D; //Video 2 DVI-D (Digital)* (OPT1 swaps Video1 & Video2)

```

\* T440: OPT6 switch ON will use S-Video in place of HDMI/DVI. T430: Uses DVI-D for Video2

```

Input4 := 0D + '*sour=svid#' + 0D; //Video2 S-Video*
Input5 := 0D + '*sour=yprb#' + 0D; // Component
Input6 := 0D + '*sour=dvid#' + 0D; // DVI-D (Digital)
Input7 := 0D + '*sour=hdmi#' + 0D; // HDMI

```

Any one of these codes can be set into Constant:0/Constant:1 for computer codes and Constant:2/Constant:3 for video codes. (The default is to have Computer1 (above) as the “Computer” channel and Video1 as the “Video” channel. Setting OPT1 switch ON will swap Video1 and Video2 channels, making S-Video the video default. Setting OPT5 will swap Computer1 and Computer2. Setting OPT4 will allow double- presses on some keyboards.).

- OPT7 handshake mode and power on panel connection blink codes available ;
- Source scan must be turned off using normal on-screen menu options;
- RS232 communications must be enabled and baud rate set to 19200 in the SYSTEM SETUP: Advanced menu;
- Freeze and mute are toggle mode in these projectors (despite the manual stating absolute commands: this is a lie!), but status read-back is provided and used in the T440 driver to simulate absolute mute commands. Thus 2-yellow-button mute mode is supported on keyboard codes 2, 9 and BL/P, both with projector internal audio and T441/T461 audio: **OPT7 must be ON for this;**
- Audio functions have one RCA pair for Video/S-Video, one 3.5mm jack for both computers and a stereo 3.5mm output with controlled audio. Use a T441/T461 if more audio control is needed. (On the test device we found audio limited, with only 10 audio levels and an unexplained stopping of all audio.)

## RS232 connections to BenQ MP724, MP727, MP735 with D9

These use a 9-pin-D9 male on the proj, female on cable. Comms is at 19200 baud, 8 N1.

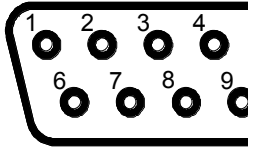
Function/Direction	T440 “projector” Connection	“Serial” Port Connector	 <p>D-sub 9 female</p>
Ground	Ground	9-pin D-sub pin 5	
Data from T440 to projector	Tx	9-pin D-sub pin 2 (RXD)	
Reply data from projector to T440	Rx	9-pin D-sub pin 3 (TXD)	
Plus 9 volt CTS/DTR to projector	n/c	n/c	

After installation wiring of any projector to a T440, use a multimeter to check voltages of -9 on BOTH TX and RX pins in any installation, as described in the troubleshooting part of this manual.

**BenQ MP512 MP513, MP522, MP626, MP623, MP624, MP670, MP772st, MP776st, MP777, MX750/MP780st, SP920, PW9500 (Code 3F allows HDMI for Computer: 2, Code 4A allows HDMI for Video 2 or 1, RGB2 for Computer:2)**

**MP551 (Code 4B ), MP525/MP525P/MP575, MP626/MP576 (No HDMI/RGB2), MP515ST/MP525ST (HDMI version) (Code 4C)**

**\*MS614, MW714st / MW811st, MX615, MX660P, MX710 / MX711, MX713ST / MX810ST, MX762ST / MX812ST, MX763, MX764, MX760 / MX761, MX712UST / MX880UST, MX716/MX717 (Code 7C with Vid2->S-Video, Code 7F with Vid2->HDMI)**

**\*SP840, W600, Th681 (2 x HDMI, allows HDMI1 for Video and HDMI2 for Computer, Code 7D)**

\* Note: Most recent BenQ fit into these categories. Try these with unknown BenQ units.

Channel codes for these are:

```
Input1 := 0D + '*sour=RGB#' + 0D;           //Computer1 Analog RGB DB15 (some YPbPr1)
Input2 := 0D + '*sour=hdmi#' + 0D;           //Computer2 HDMI Code <<<<<<<<<<< 3F, 4C
or
Input2 := 0D + '*sour=RGB2#' + 0D;           //Computer2 Analog RGB DB15 no 2 <<< 4A, 4B, 7C
or
Input2 := 0D + '*sour=hdmi2#' + $0D;         //Computer2 HDMI 2 <<< 7D

Input3 := 0D + '*sour=vid#' + 0D;           //Video1 Composite Video RCA (OPT1 swaps Video1 & Video2)
Input4 := 0D + '*sour= hdmi #' + 0D;         //Video 2 DVI-D (Digital)* (OPT1 swaps Video1 & Video2)
```

\* T440: OPT6 switch ON will use S-Video in place of HDMI/DVI. T430: Uses HDMI for Video2

```
Input4 := 0D + '*sour=svid#' + 0D;           //Video2 S-Video*
Input5 := 0D + '*sour=ypr#' + 0D;           // Component
Input6 := 0D + '*sour=dviA#' + 0D;           // DVI-A (Analog)
Input7 := 0D + '*sour=dviD #' + 0D;          // HDMI (Digital)
Input8 := 0D + '*sour=hdmi#' + 0D;           // HDMI
Input9 := 0D + '*sour=hdmi2#' + 0D;          // HDMI 2
Input10 := 0D + '*sour=RGB2#' + 0D;           // Computer2 Analog RGB DB15
Input11 := 0D + '*sour=net#' + 0D;           // network
Input12 := 0D + '*sour=svid#' + 0D;          //Video2 S-Video
```

Any one of these codes can be set into Constant:0/Constant:1 for computer codes and Constant:2/Constant:3 for video codes. (The default is to have Computer1 (above) as the “Computer” channel and Video1 as the “Video” channel. Setting OPT1 switch ON will swap Video1 and Video2 channels, making S-Video the video default. Setting OPT5 will swap Computer1 and Computer2. Setting OPT4 will allow double- presses on some keyboards.).

NOTE: Tests of the MP525ST have revealed an intermittent failure to communicate in the “standby” state, showing up as a failure to respond to the communications test (pushing the RED OFF key and watching ONE flash, not three) and a failure to start. This would appear to be fixed by entering factory setup mode and turning “Full Power Standby” to ON.

- OPT7 handshake mode and power on panel connection blink codes available for code 3F, 4A, 7C and 7F family, but ONLY power-on-blink for code 4B and 4C projectors;
- “Source scan”, or “Quick Auto Search” must be turned off using normal on-screen menu options;
- **RS232 communications must be enabled (some only) and baud rate set to 19200** in the “System Setup: Advanced” menu. **If this is not done, you will NOT communicate!;**
- In “System Setup: Advanced” | Standby Settings | press Enter, then set “Network” to ON to enable RS232 coms.
- Audio functions on some are limited to one audio input and no output, although it seems the MP626/MP670 and MP870st does have 2 audio ins and correctly controlled audio OUT. (Use a T441/T461 if audio control is needed;)

- Freeze and mute are absolute in these projectors, and 2-yellow-button mute mode is supported when running with a T441/T461 doing audio control. It is supported on the MP626, MP670, MP780st, MW714st and MW811st with their limited audio. (The last two have only one audio channel, with no audio on RGB inputs);
- Turn OFF “Auto-Power-On”, so the projector does not auto-start when power is cycled or drops out with power failures.

On some which do not have a standby select mode:

1. Using keypad:

- a) Press “Menu” on keypad
- b) When showing main menu, press "Source" + "Mode" at the same time
- c) Factory menu popup at the top - left of display

2. In factory mode, use “Down” arrow and change “Full Power Standby” to “ON”. Push “Menu” twice to exit

### Aspect ratio setting for BenQ family

The aspect ratio codes for these BenQ projectors are the same, but are interpreted differently with different models.

Note that to use these, enable bits for ratios usable by each channel must be set into UserFlags[0..3] and the preselected or “default” aspect setting must be set into UserFlags[5..8]

```
SetAspect1 := 0D + '*asp=4:3#' + 0D; // Reg 4:3
SetAspect2 := 0D + '*asp=16:9#' + 0D; // 16:9
```

(Note that initial aspect ratio commands do not appear to be accepted if there is no signal input to that channel.)

### RS232 connections to BenQ projectors with D9, MP623, MP624, MW714st / MW811st, MX710 / MX711, MX760 / MX761 etc, MP780st

These all use a D-sub 9-pin connector, female on projector, male on cable. Communications runs at 19200 8N1.

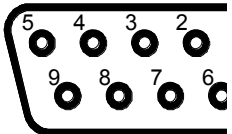
Function/Direction	T440 “projector” Connection	Projector Connector (Male on cable)	
Ground	Ground	9-pin D-sub pin 5	 <p>D-sub 9 mal</p>
Data from T440 to projector	Tx	9-pin D-sub pin 2 (RXD)	
Reply data from projector to T440	Rx	9-pin D-sub pin 3 (TXD)	
Plus 9 volt CTS/DTR to projector	N/C	N/C	

After installation wiring of any projector to a T440, use a multimeter to check voltages of -9 on BOTH TX and RX pins in any installation, as described in the troubleshooting part of this manual.

## BenQ SP820, Optoma Group 5: EP771, EP772, EP774 projectors (Code 3B)

(Message formats are ASCII with format: “~PN<CR>” for Power On, “~SR<CR>” for RGB select, etc.)

Channel codes are:

```

Input1 := '~SR' + 0D; //Computer1 RGB analog-RGB VGA
Input2 := '~SD' + 0D; //Computer2 DVI

Input3 := '~SV' + 0D; //Video1 Comp Video (OPT1 swaps Video1 & Video2)
Input4 := '~SH' + 0D; //Video2 HDMI * (OPT1 swaps Video1 & Video2)
    
```

\* T440: OPT6 switch ON will use S-Video in place of HDMI/DVI. T430: Uses HDMI for Video2.

```

Input4 := '~SS' + 0D; //Video2 S-Video *

Input5 := '~SY' + 0D; // Component via DB15
Input6 := '~SH' + 0D; // HDMI
Input7 := '~SG' + 0D; // Computer2 RGB analog-RGB VGA
Input8 := '~SD' + 0D; // Computer2 DVI for Vivitek use
Input9 := '~SW' + 0D; // Wireless
    
```

Any one of these codes can be set into Constant:0/Constant:1 for computer codes and Constant:2/Constant:3 for video codes. (The default is to have Computer1 (above) as the “Computer” channel and Video1 as the “Video” channel. Setting OPT1 switch ON will swap Video1 and Video2 channels, making S-Video the video default. Setting OPT5 will swap Computer1 and Computer2. Setting OPT4 will allow double- presses on some keyboards.).

- OPT7 handshake mode and power on panel connection blink codes available;
- You must turn off “Auto Source” in “Config” menu;
- You must turn off “Auto Power Off” and ‘Direct Power On” in “Config” menu.
- Freeze and mute toggle only with the “Freeze/Mute” keyboard. No LEDs flash in the “Mute” state. No 2-yellow-button mute is provided with a “Volume” keyboard as the limited projector codes cannot command absolutely or read back the mute state;

## RS232 connections to BenQ SP820, Optoma EP771/772 projector with D9

These use a 9-pin-D9 male on the proj, female on cable. Comms is at 9600 baud, 8 bits, no parity, 1 stop.

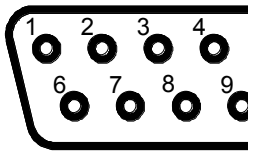
Function/Direction	T440 “projector” Connection	“Serial” Port Connector	
Ground	Ground	9-pin D-sub pin 5	 <p>D-sub 9 female</p>
Data from T440 to projector	Tx	9-pin D-sub pin 3 (RXD)	
Reply data from projector to T440	Rx	9-pin D-sub pin 2 (TXD)	
Plus 9 volt CTS/DTR to projector	n/c	n/c	

**After installation wiring of any projector to a T440, use a multimeter to check voltages of –9 on BOTH TX and RX pins in any installation, as described in the troubleshooting part of this manual.**



## Canon: SX6000/WX6000, SX80 MkII / SX800, WUX10 Mk II (Code 1C)

WUX4000/WUX5000 (Code 1D)

(Message formats are ASCII)

Channel codes are:

```
Input1 := 'INPUT=A-RGB1' + 0D; // Computer1 on DB9 (Shared with Component in) (Code 1C)
or
Input1 := 'INPUT=A-RGB' + 0D; // no RGB2 (On DVI) (Code 1D)
Input2 := 'INPUT=A-RGB2' + 0D; // Computer2 on DVI-I INPUT (Code 1C)
or
Input2 := 'INPUT=D-RGB' + 0D; // no RGB2 (On DVI) (Code 1D)
Input3 := 'INPUT=HDMI' + 0D; // HDMI
Input4 := 'INPUT=VIDEO' + 0D; // Video1
Input5 := 'INPUT=COMP' + 0D; // Component
Input6 := 'INPUT=S-VIDEO' + 0D;
Input7 := 'INPUT=D-RGB' + 0D; // DVI-D
Input8 := 'INPUT=USB' + 0D; //USB
```

Any one of these codes can be set into Constant:0/Constant:1 for computer codes and Constant:2/Constant:3 for video codes. (The default is to have Computer1 (above) as the “Computer” channel and Video1 as the “Video” channel. Setting OPT1 switch ON will swap Video1 and Video2 channels. Setting OPT5 will swap Computer1 and Computer2. Setting OPT4 will allow double- presses on some keyboards.)

This projector has not been tested live, so feedback on operation, including warm-up times and cooldown times would be welcome.

- Power on panel connection blink code is available. (Please confirm if this works OK);
- There may well be auto-source functions to turn off and standby mode to setup to enable RS232. These are not mentioned in the manual.

**These projectors use a D9 connector, so check the connections in the manual. After, use a multimeter to check voltages of –9 on BOTH TX and RX pins in any installation, as described in the troubleshooting part of this manual.**

**Casio XJ-A, XJ-M, XJ-UT310WN, XJ-V1, V2 series projectors (LED/Laser) (1 VGA RGB, 1 HDMI) (Code 6D)** Includes XJ-A142/XJ-A147, XJ-A242/XJ-A247, XJ-A252/XJ-A257, XJ-M140/XJ-M145, XJ-M141/XJ-M247, M150/XJ-M155, XJ-M151/XJ-M156, XJ-M240/XJ-M245, XJ-M241/XJ-M246, XJ-M250/XJ-M255, XJ-M251/XJ-M256

**XJ-H, XJ-ST (has 2 VGA RGB ports) (Code 6E)**, Includes XJ-H1600, XJ-H1650, XJ-H1700, XJ-H1700, XJ-ST145, XJ-ST155

**XJ-F, XJ-V, XJ-U (has 2 HDMI ports) (Code 6F)** Includes XJ-F10X/XJ-F20XN, XJ100W/XJF200WN, XJ-F210WN, XJ-V10X/XJ-V100W/XJ-V110W, XJ-UT311WN/UT331X/UT351W/N

Manuals, with codes are at: <http://support.casio.com/en/manual/manuallist.php?cid=007>

Channel codes are:

Input1 := '(SRC0)'; // (all) Computer1 DSUB15 VGA / RGB

**Code 6D:** Input2 := '(SRC7)'; // Computer2 "HDMI" (XJ-M, XJ-A, XJ-UT310, XJ-V1/V2)

or

**Code 6E:** Input2 := '(SRC3)'; // Computer2 "RGB2" (XJ-H, XJ-ST)

or

**Code 6F:** Input2 := '(SRC14)'; //Computer2 =HDMI 2 (XJ-F, XJ-V)

Input3 := '(SRC2)'; // (all) Video1 RCA Composite (OPT1 swaps Video1 & Video2)

Input4 := '(SRC7)'; // (all) Video2 HDMI / HDMI 1\* (OPT1 swaps Video1 & Video2)

\* T440: OPT6 switch ON will use S-Video in place of HDMI/DVI. T430: uses HDMI for Video2

Input4 := '(SRC9)'; // (all) Video2 S-Video \*

Input5 := '(SRC1)'; // (all) Component 1

Input6 := '(SRC4)'; // (XJ-H) Component 2

Input7 := '(SRC6)'; // (all) Auto 1 (RGB1/Component1)

Input8 := '(SRC10)'; // (XJ-H, XJ-ST) Auto 2 (RGB2/Component2)

Input9 := '(SRC7)'; // (all) HDMI

Input10 := '(SRC5)'; // (all)USB (OR Wireless)

Input11 := '(SRC11)'; // File viewer

Input12 := '(SRC12)'; // USB Display

Input13 := '(SRC13)'; // Casio USB tool

Input14 := '(SRC14)'; // HDMI 2 (XJ-F, XJ-V, XJ-U)

Any one of these codes can be set into Constant:0/Constant:1 for computer codes and Constant:2/Constant:3 for video codes. (The default is to have Computer1 (above) as the "Computer" channel and Video1 as the "Video" channel.

Setting OPT1 switch ON will swap Video1 and Video2 channels, making S-Video the video default.

Setting OPT5 will swap Computer1 and Computer2.

Setting OPT4 will allow double- presses on some keyboards..

- OPT7 handshake mode and power on panel connection blink codes available;
- You must turn off "Auto Source" in "Config" menu;
- You must turn off "Direct Power On" in "Option settings 1" menu.
- Mute/Blank on/off with the "Freeze/Mute" keyboard. Two-yellow button "Mute" command is supported;
- These typically have one PC audio, one Video audio and one HDMI audio input. Audio volume control from the T440 (or the set-top menu) controls audio to the internal 2" speaker. **However, the audio output from the line-output connector is NOT controlled.** For audio level control, use a JED T441 (2-channel) or a T461 (4-channel) audio system. (You must select Audio to "Line" in the "Option Settings 2", then "Audio Out" menus.) (The strange effect may be different in more recent models).

## Aspect ratio control

```

SetAspect1 := '(ARZ0)'; // 4:3 "Normal" RGB or HDMI(PC)
SetAspect2 := '(ARZ1)'; // 16:9 *
SetAspect3 := '(ARZ2)'; // 4:3 "Normal" Vid S-Vid, Comp, HDMI(TV) *
SetAspect4 := '(ARZ3)'; // Letterbox
SetAspect5 := '(ARZ4)'; // Full
SetAspect6 := '(ARZ5)'; // True
  
```

\* In testing , only 4:3 and 16:9 seem to work.

## RS232 connections to Casio XJ-M, XJ-H series projectors (LED/Laser)

These use a 9-pin-D9 male on the panel, female on cable. Coms is at 19200, 8N1

Function/Direction	T460 "projector" Connection	Fujitsu "Control" Port Connector
Ground	Ground	9-pin D-sub pin 5
Data from T440 to projector	Tx	9-pin D-sub pin 2 (RXD)
Reply data from projector to T440	Rx	9-pin D-sub pin 3 (TXD)
Plus 9 volt CTS/DTR to projector	N/C	N/C

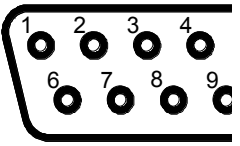

D-sub 9 female

After installation wiring of any projector to a T460, use a multimeter to check voltages of -9 on BOTH TX and RX pins in any installation, as described in the troubleshooting part of this manual.

## Christie 115200 (Code 9E), 19200 (Code 9F)

E series: DHD675-E, DWU675-E, DHD775-E, DWU775-E,  
 G series: DHD550-G, DWU550-G, DWX600-G, DHD600-G, DWU600-G  
 DUW350S/400S (will need some inputs set manually)  
 LWU650-APS use Hitachi Code 45

This group of large-venue projectors has no audio, but does have a Picture blank On / Off

Channel codes are:

```

Input1 := '(SIN1)'; // Computer1 VGA1 (VGA2 on E Series)
Input2 := '(SIN4)'; // Computer2 HDMI2 (HDMI on DWU555)

Input3 := '(SIN9)'; // Video1 Comp Video (some)
Input4 := '(SIN3)'; // Video2 HDMI1 (not on DWU555)

Input5 := '(SIN0)'; // VGA1 (E series)
Input6 := '(SIN2)'; // BNC (Some only) (VGA2 on DUW350S/400S)

Input7 := '(SIN3)'; // HDMI 1
Input8 := '(SIN4)'; // HDMI 2

Input9 := '(SIN5)'; // DVI-D or Composite or Component

Input10 := '(SIN6)'; // DisplayPort (Multimedia on DUW350S/400S, S-Video on E-Series)
Input11 := '(SIN7)'; // Component (Composite on E-Series)

Input12 := '(SIN8)'; // S-Video (some)
Input13 := '(SIN10)'; // Presenter (some)
Input14 := '(SIN11)'; // Cardreader (some)
Input15 := '(SIN12)'; // Mini USB (some)
  
```

Any one of these codes can be set into Constant:0/Constant:1 for computer codes and Constant:2/Constant:3 for video codes. (The default is to have Computer1 (above) as the “Computer” channel and Video1 as the “Video” channel.

Setting OPT5 will swap Computer1 and Computer2.

Setting OPT1 will swap Video1 and Video2 channels

Setting OPT4 will allow double- presses on some keyboards..

- Power on panel connection blink codes are not available;
- Blank on/off is supported on a “Freeze/Mute” keyboard.

## RS232 connections to Christie projectors

These use a 9-pin-D9 male on the projector, female on cable. Comms is at 115200 8N1.

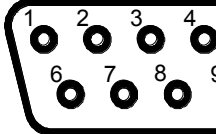
Function/Direction	T430/440 “projector” Connection	Epson ESC-VP21 “Control” Port Connector	 D-sub 9 fem
Ground	Ground	9-pin D-sub pin 5	
Data from T460 to projector	Tx	9-pin D-sub pin 2 (RXD)	
Reply data from projector to T460	Rx	9-pin D-sub pin 3 (TXD)	
Plus 9 volt CTS/DTR to projector	N/C	N/C	

**After installation wiring of any projector to a T440, use a multimeter to check voltages of –9 on BOTH TX and RX pins in any installation, as described in the troubleshooting part of this manual.**

## DELL projectors (Code 4D)

This family has many members with a range of channel messages. Most just support a VGA, a Composite and an S-Video input. Some have HDMI

Models covered are 1200MP, 1201MP, 1209S, 1409X, 1510X, 1609WX, 1610HD, 1800MP, 2400MP, 4100MP, 4210X, 4220, 4310X, 4320, 4610X, 5100MP, 7609WU, S300/W/WI, S500wi.

In the back of each user's manual is a list of typical channel selection messages. These are accessible at:

[http://support.dell.com/support/topics/global.aspx/support/my\\_systems\\_info/manuals?c=us&cs=45&l=en&s=bsd&~ck=anavml](http://support.dell.com/support/topics/global.aspx/support/my_systems_info/manuals?c=us&cs=45&l=en&s=bsd&~ck=anavml) (Then select "Choose a model", then "Electronics", then "Projector", then a particular model.)

Channel codes are:

Input1 := BE + EF + 10 + 05 + 00 + CC + FF + 11 + 11 + 01 + 00 + 19; //Computer1 VGA RGB1 Analog (all)  
 Input2 := BE + EF + 10 + 05 + 00 + CF + 3F + 11 + 11 + 01 + 00 + 1C; //Computer2 M1 ANALOG DVI connector  
 (4100MP, 5100MP, VGA2 on 1800MP)

Input3 := BE + EF + 10 + 05 + 00 + DF + 7F + 11 + 11 + 01 + 00 + 23; //Video1 Composite Video RCA (all)  
 Input4 := BE + EF + 10 + 05 + 00 + 3A + 3E + 11 + 11 + 01 + 00 + 50; //Video2 HDMI 1\* (all)

\* T440: OPT6 switch ON will use S-Video in place of HDMI/DVI. (OPT1 swaps Video1 & Video2)  
 T430: Uses HDMI as Video2

Input5 := BE + EF + 10 + 05 + 00 + DE + 3F + 11 + 11 + 01 + 00 + 20; //YPbPr via RCA (4100MP, 5100MP  
 7609WU)

Input6 := BE + EF + 10 + 05 + 00 + CD + BF + 11 + 11 + 01 + 00 + 1A; //VGA Component (1200MP, 1201MP,  
 4100MP, 5100MP)

Input7 := BE + EF + 10 + 05 + 00 + 28 + FE + 11 + 11 + 01 + 00 + 69; //VGA RGB2 Analog (1209S, 7609WU)

Input8 := BE + EF + 10 + 05 + 00 + 0F + FE + 11 + 11 + 01 + 00 + 1D; //M1 Digital DVI (4100MP, 5100MP)

Input9 := BE + EF + 10 + 05 + 00 + 3A + 3E + 11 + 11 + 01 + 00 + 50; //HDMI 1 (any with HDMI)

Input10 := BE + EF + 10 + 05 + 00 + E9 + 7F + 11 + 11 + 01 + 00 + 6B; //HDMI 2 (7609WU)

Any one of these codes can be set into Constant:0 / Constant:1 for computer codes and Constant:2 / Constant:3 for video codes. (The default is to have Computer1 (above) as the "Computer" channel and Video1 as the "Video" channel. Setting OPT1 switch ON will swap Video1 and Video2 channels, making S-Video the video default. Setting OPT5 will swap Computer1 and Computer2. Setting OPT4 will allow double-presses on some keyboards.).

- No OPT7 handshake mode and power on panel connection blink codes are available, as no status read-back;
- Mute is toggle, and is only available on code A keyboards;
- FREEZE is supposed to be supported on some, but tested codes do NOT work on a 2400MP. They may work on 4100MP/5100MP, but not tested. Thus a Code8 or A keyboard may have a non-functioning Freeze key;
- On keyboards with volume keys, incremental Volume up and down is supported. Mute is NOT supported because there is no read-back of mute status. It is not supported in OPT8 T441/T461 mode either, because of no read-back;

(2300MP is not supported, as it has no absolute power on/off commands and no status read-back.)

## RS232 connections to DELL projectors.

Communication is at 19200 8N1

To connect the T440 to these projectors use a mini-DIN 6 male on the cable:

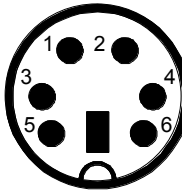
Function/Direction	T440 "projector" Connection	Projector Connector Connector 6-pin mini-DIN	
Ground	Ground	Mini-DIN Pins 1, 2	 <p>Mini-DIN 6</p>
Data from T440 to projector	Tx	Mini-DIN Pin 3 (RXD)	
Reply data from projector to T440	Rx	Mini-DIN Pin 5 (TXD)	
Plus 9 volt CTS/DTR to projector	N/C	N/C	

**After installation wiring of any projector to a T440, use a multimeter to check voltages of -9 on BOTH TX and RX pins in any installation, as described in the troubleshooting part of this manual.**

**Eiki projector LC-WIP3000, LC-WSP3000 XDP-3500, XIP-2610, XSP-2600, (Code 81 ), LC-XIP2000, LC-XIP-2600, LC-XNP4000 (Code 84 )**

These have code similarities to Sanyo, but are unique, with 9600 baud coms, and non-absolute audio.

Manuals and a code sheet on the XDP-3500 are at: <http://www.eiki.com/usa/products/projectors/hd-widescreen>

Channel codes are:

```

Input1      := 'C02' + 0D;    //Computer1 Input 1 Analog RGB DB15
Input2      := 'C04' + 0D;    //Computer2 Input 2 Analog RGB DB15**

Input3      := 'C06' + 0D;    //Video1 Input 3 Composite Video RCA* (OPT1 swaps Video1 & Video2)
Input4      := 'C05' + 0D;    //Video2 Input DVI / HDMI* (OPT1 swaps Video1 & Video2)

* T440: OPT6 switch ON will use S-Video in place of HDMI/DVI. T430: uses HDMI for User2

Input4      := 'C07' + 0D;    //Video2 S-Video V064

Input5      := 'C03' + 0D;    // Y, Pb/Cb, Cb/Cr (Component)**
Input6      := 'C05' + 0D;    // Input HDMI or DVI (PC Digital)
Input7      := 'C08' + 0D;    // Input RCA Component
    
```

For XDP3500, Computer 2 (Code C03) and YPbPr (Code C04) as swapped in some documents.

LC-WIP3000, LC-WSP3000 XDP-3500, XIP-2610, XSP-2600 have absolute Mute, Blank and Freeze so all keyboards with two yellow volume buttons allow 2-Button Mute. The others have toggle mode only. Code 8 and A keyboards toggle Blank and Freeze work with all these (absolute and toggle modes).

Any one of these codes can be set into Constant:0/Constant:1 for computer codes and Constant:2/Constant:3 for video codes. (The default is to have Computer1 (above) as the “Computer” channel and Video1 as the “Video” channel. Setting OPT1 switch ON will swap Video1 and Video2 channels, making HDMI the video default. Setting OPT5 will swap Computer1 and Computer2. Setting OPT4 will allow double- presses on some keyboards.).

**Unfortunately the audio system commands are unreliable (on tests of the LC-XIP2000, LC-XIP-2600)... 50% of the time they actually change the source! So these projectors are only recommended to operate with external audio control, eg in a manual mixing desk in a worship site or, if audio is controlled by a T440, a T441 (2 channels) or T461 (4 channels) is needed.**

- Power on panel connection blink codes are provided, and OPT7 handshake mode is provided;
- Auto Pixel Align is available;
- Picture and sound mute is available with two-yellow-button mute mode with a “volume” keyboard (LC-WIP3000, LC-WSP3000 XDP-3500 only);
- Mute and freeze keyboard code 8 or A, or any non-audio keyboard is usable. If audio is needed, use a T441 or T461;
- Make sure to turn off “Auto input search”;
- Make sure to set the baud rate to 9600 and no parity (if an adjustment menu is provided.)

**RS232 connections to Eiki XDP/XIP with D9**

These use a 9-pin-D9 male on the plasma, female on cable. Comms is at 9600 baud, 8 bits, no parity, 1 stop.

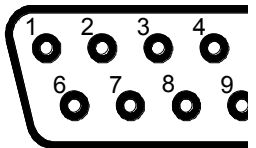
Function/Direction	T460 “projector” Connection	“Serial” Port Connector	 <p>D-sub 9 female</p>
Ground	Ground	9-pin D-sub pin 5	
Data from T460 to panel	Tx	9-pin D-sub pin 3	
Reply data from panel to T460	Rx	9-pin D-sub pin 2	
Plus 9 volt CTS/DTR to panel	N/c	N/c	

After installation wiring of any projector to a T460, use a multimeter to check voltages of -9 on BOTH TX and RX pins in any installation, as described in the troubleshooting part of this manual.

## Epson VP21 projectors (Codes 0C, 0D, 0E, 75 ... 77 )

Typical models are: EB-84/H/He/L/+, EB-85/H/HV/+, EB92, EB93e, EB95, EB96W, EB-97, EB-98, EB-400, EB-410W, EB-420, EB-425W, EB-430, EB-435W, EB-440W, EB-450W/e/i, EB-455Wi, EB-460e/i, EB-465i, EB-470, EB-475W/Wi, EB-480/I, EB-485W/Wi, EB-520, EB-525W, EB-530, EB-535W, EB-536Wi, EB-570, EB-575W/I, EB-580, EB-585W/I, EB-590Wt, EB-595WiEB-824/H, EB-825/H/HV/+, EB-826/WH/WHV/W+, EB-900, EB-905, EB-910W, EB-915W, EB-925, EB-940, EB-945, EB-950W, EB-955W, EB-965, EB-1400Wi, EB-1410Wi, EB-1830, EB-1840W, EB-1850W, EB-1860, EB-1870, EB-1880, EB-1900, EB-1910, EB-1915, EB-1920W, EB-1925W, EB-1925W, EB-1930, EB-1935, EB-1940W, EB-1945W, EB-1950, EB-1954/W, EB-1955, EB-1960, EB-1964, EB-1965, EB-1970W, EB-1975W, EB-1980WU, EB-1985WU, EB-4550, EB-4650, EB-4750W, EB-4850WU, EB-4855WU, EB-4950WU, EB-4955WU, EB-S11, EB-S11H, EB-S12, EB-W17, EB-W28, EB-X11, EB-X11H, EB-X14H, EB-X15, EB-X17, EB-X20, EB-S17, EB-S21, EB-X21, EB-W22, EB-X22, EB-X25, EMP 30/52/53/54/61/73/74/81/62/82, EMP-83(83e), EMP-83H(83+/83He/83V+), EMP-260/280/400W/600/800/810/811/820/821, EMP-822(822H(822+), EMP-828/830/835 EMP-6000/6010/6100/6110/1810/1815/1825/7800/7850/7900/7950/8300/9300/S1/S1H, EMP-G5350/G5300/G5200W/G5150/G5100/G5000, EMP-84/85/824/825/826W

In the back of each user's manual is a list of typical channel selection messages (SOURCE xx),

**Code 0C** : Channel codes are:

```
Input1 := 'SOURCE 11' + 0D; //Computer1 DSUB1 VGA analog-RGB
Input2 := 'SOURCE 21' + 0D; //Computer2 DSUB2 VGA analog-RGB (Code 0D puts HDMI here.)

Input3 := 'SOURCE 41' + 0D; //Video1 Comp Video *(OPT1 swaps Video1 & Video2)
Input4 := 'SOURCE 30' + 0D; //Video2 HDMI * *(OPT1 swaps Video1 & Video2)
```

\* T440: OPT6 switch ON will use S-Video in place of HDMI/DVI. T430: uses HDMI for Video2

```
Input5 := 'SOURCE 14' + 0D; // Component on DSUB1 or YCbCr on DSUB1
Input6 := 'SOURCE 15' + 0D; // YCbCr on DSUB1

Input7 := 'SOURCE 24' + 0D; // Component on DSUB2 or YCbCr on DSUB2
Input8 := 'SOURCE 25' + 0D; // YCbCr on DSUB2

Input9 := 'SOURCE 30' + 0D; // DVI-D or HDMI1
Input10 := 'SOURCE 31' + 0D; // Digital RGB
Input11 := 'SOURCE 33' + 0D; // RGB Video
Input12 := 'SOURCE 34' + 0D; // YCbCr
Input13 := 'SOURCE 35' + 0D; // YPbPr

Input14 := 'SOURCE 41' + 0D; // Video RCA
Input15 := 'SOURCE 42' + 0D; // S-Video
Input16 := 'SOURCE 43' + 0D; // Video YCbCr
Input17 := 'SOURCE 44' + 0D; // Video YPbPr
Input18 := 'SOURCE 45' + 0D; // Video BNC

Input19 := 'SOURCE 50' + 0D; // LAN
Input20 := 'SOURCE 51' + 0D; // USB display
Input21 := 'SOURCE 52' + 0D; // USB1 display
Input22 := 'SOURCE 53' + 0D; // LAN
Input23 := 'SOURCE 54' + 0D; // USB2 display
Input24 := 'SOURCE 55' + 0D; // Whiteboard
Input25 := 'SOURCE 56' + 0D; // Screen Mirror

Input26 := 'SOURCE 60' + 0D; // BNC SDI

Input27 := 'SOURCE 70' + 0D; // DisplayPort
Input28 := 'SOURCE 71' + 0D; // DisplayPort Digital RGB
Input29 := 'SOURCE 73' + 0D; // DisplayPort RGB-Video
Input30 := 'SOURCE 74' + 0D; // DisplayPort YCbCr
Input31 := 'SOURCE 75' + 0D; // DisplayPort YPbPr
```

```

Input32 := 'SOURCE 80' + 0D; // HDBaseT
Input33 := 'SOURCE A0' + 0D; // HDMI or HDMI2
Input34 := 'SOURCE A1' + 0D; // Dig RGB
Input35 := 'SOURCE A3' + 0D; // RGB Video
Input36 := 'SOURCE A5' + 0D; // YPbPr
Input37 := 'SOURCE B0' + 0D; // INPUT4 HDMI or HDMI2
Input38 := 'SOURCE B1' + 0D; // INPUT4 BNC analog-RGB
Input39 := 'SOURCE B2' + 0D; // INPUT4 BNC COMPONENT RGB-Video
Input40 := 'SOURCE B3' + 0D; // INPUT4 BNC COMPONENT YCbCr
Input41 := 'SOURCE B4' + 0D; // INPUT4 BNC component
Input42 := 'SOURCE C0' + 0D; // INPUT5 HDMI or HDMI2
Input43 := 'SOURCE C4' + 0D; // INPUT5 BNC COMPONENT YCbCr
Input44 := 'SOURCE C5' + 0D; // INPUT5 BNC COMPONENT YPbPr

```

Following are special group and auto “sources”

```

Input45 := 'SOURCE 10' + 0D; // INPUT 1 Button (Input 1 DB15 sources)
Input46 := 'SOURCE 1F' + 0D; // INPUT 1 Auto (Input 1 DB15 sources)
Input47 := 'SOURCE 20' + 0D; // INPUT 2 Button (Input 2 DB15 sources)
Input48 := 'SOURCE 2F' + 0D; // INPUT 2 Auto (Input 2 DB15 sources)

```

// SOURCE 30 ABOVE

```

Input49 := 'SOURCE 40' + 0D; // INPUT 2 Button (Video sources)
Input50 := 'SOURCE 50' + 0D; // INPUT 2 Button (USB sources)

```

// SOURCE 60 ABOVE // SOURCE A0 ABOVE // SOURCE B0 ABOVE

```

Input51 := 'SOURCE BF' + 0D; // INPUT 4 Button (BNC sources)
Input52 := 'SOURCE F0' + 0D; // Change Cyclic Button (All sources)
Input53 := 'SOURCE F1' + 0D; // Change Cyclic Button (PC/USB/LAN sources)
Input54 := 'SOURCE F2' + 0D; // Change Cyclic Button (Video/S-Video/HDMI sources)

```

**Code 0E: Code to send Source Roll.** The allows each press to rotate around all available sources. It sends KEY 48 to simulate the “Source” key on a remote, but sends via RS232. Uses Code 1 keyboard where the On/Source rolls through sources and Volume Up/Down keys are operational. A T440 with Code 6 (T430 keyboard with On/Source keyboard) rolls through available sources but with no volume control. A T430 operates in the same way.

**Code 75 : Special Computer codes:** Epson Home series,

EH-TW2900/3200/3500/3600/4400/4500/5500, TW5900, TW6000/W, TW8000/W, TW9000/W

```

Input1 := 'SOURCE 21' + 0D; //Computer1 DSUB2 VGA analog-RGB
Input2 := 'SOURCE 30' + 0D; //Computer2 INPUT3, HDMI or DVI-D

```

**Code 76 : Special Composite Video code:**

Epson EB-G5450, EB-G5500, EB-G5600, EB-G5650, EB-G5600W, EB-G5750WU, EB-G5800, EB-G5900, EB-G5950, EB-G5550

```

Input3 := 'SOURCE 45' + 0D; // Video1 Comp Video via BNC (Note: Input 18 is avail as alt Comp Vid.)

```

**Code 77 : Special Composite Video code and HDMI codes:**

Epson EB-Z Generic: EB-Z8000W, EB-Z8050WU, EB-Z8150, EB-Z8250, EB-Z8350W, EB-Z8355W, EB-Z8450WU, EB-Z8455WU, EB-Z9750WU, EB-Z9800, EB-Z9805W, EB-Z9810, EB-Z9850W, EB-Z9900, EB-Z10000, EB-Z10005

```

Input1 := 'SOURCE 11' + 0D; //Computer1 DSUB1 VGA analog-RGB
Input2 := 'SOURCE A0' + 0D; //Computer2 HDMI or HDMI2
Input3 := 'SOURCE 45' + 0D; //Video1 Comp Video via BNC *(OPT1 swaps Video1 & Video2)
Input4 := 'SOURCE 30' + 0D; // INPUT3, HDMI or DVI-D *(OPT1 swaps Video1 & Video2)

```

T440: If OPT6 On: Input4 := 'SOURCE 42' + 0D; //Video2 S-Video ) T430: Uses HDMI for Video2

Any one of these codes can be set into Constant:0/Constant:1 for computer codes and Constant:2/Constant:3 for video codes. (The default is to have Computer1 (above) as the “Computer” channel and Video1 as the “Video” channel. Setting OPT1 switch ON will swap Video1 and Video2 channels, making S-Video the video default. Setting OPT5 will swap Computer1 and Computer2. Setting OPT4 will allow double- presses on some keyboards.)



- OPT7 handshake mode and power on panel connection blink codes available.

## Aspect ratio setting for Epson family

The aspect ratio codes for all Epson projectors are the same, but are interpreted differently with different models. Note that to use these, enable bits for ratios usable by each channel must be set into UserFlags[0..3] and the preselected or “default” aspect setting must be set into UserFlags[5..8] The functions provided are as follows:

```
SetAspect1 := 'ASPECT 10' + 0D; // Regular video image 4:3
SetAspect2 := 'ASPECT 20' + 0D; // Wide video image 16:9 or 16:10
SetAspect3 := 'ASPECT 21' + 0D; // Wide video image 16:9 Upper
SetAspect4 := 'ASPECT 22' + 0D; // Wide video image 16:9 Lower
SetAspect5 := 'ASPECT 30' + 0D; // Auto
SetAspect6 := 'ASPECT 40' + 0D; // Full
SetAspect7 := 'ASPECT 50' + 0D; // Zoom
SetAspect8 := 'ASPECT 60' + 0D; // Through/Real
```

(Note that initial aspect ratio commands do not appear to be accepted if there is no signal input to that channel.)

## RS232 connections to Epson ESC-VP21 projectors

These use a 9-pin-D9 male on the projector, female on cable. Communications is at 9600 baud 8N1.

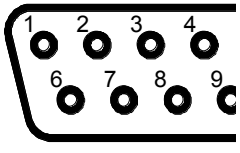
Function/Direction	T440 “projector” Connection	Epson ESC-VP21 “Control” Port Connector	
Ground	Ground	9-pin D-sub pin 5	 <p>D-sub 9 female</p>
Data from T440 to projector	Tx	9-pin D-sub pin 2 (RXD)	
Reply data from projector to T440	Rx	9-pin D-sub pin 3 (TXD)	
Plus 9 volt CTS/DTR to projector	N/C	N/C	

After installation wiring of any projector to a T440, use a multimeter to check voltages of -9 on BOTH TX and RX pins in any installation, as described in the troubleshooting part of this manual.

## Epson S/W/X5/6/7/8/9/10/11/12/13/14 (etc.) IR controlled projectors (A0 ... A3 )

**Code A0:** EB-S5(S5+/S52/T5), EB-S04/S300/S130/S04E, EB-S31/EX3240/VS240/S31+, EB-U32/EX9200/1284/U32+, EB-W04/W130/VS345/W04+, EB-31, EB-W32/EX7240/1264/W32+, EB-X4/X300/X130,VS340, EB-X31/X31E/X350/EX5240/1224, EB-X5(77c/X52/X5e/X5E), EB-X36/EX5250/X36+, EB-X56(EX90/X68)

**Code A1:** EB-S6(S6+/S62/EX30/EX31), EB-X6(72/X62/X6e/EX50)

**Code A2:** EB-92, EB-1750, EB-1760, EB-1760W(C260MN), EB-1770W(C300MN/C3010N), EB-1775W(C300MS), EB-S7(S72)/W7/X7(79/X72), EB-S8(EX31/S8+/S82), EB-S9(VS200/S92/C250S), EB-S10(EX3200/S10+/C260S), EB-W6(W6+/EX70/HC700), EB-W9(C250W), EB-W10(EX7200/1260/W10+/C260W), EB-X8(E51/X8e)/W8(EX71/W8+), EB-X9(X92/C250X/C250XS/C250XC), EB-X10(EX5200/1220/X10+/C260X/C260XS), EB-W12(EX7210/1261W/W12+/C55W), EB-X12(EX5210/1221/C30X), EB-W02(VS315W/W110/C50W), EB-X02(VS310/C20X), EB-S02(VS210/C05S/S110), EB-S01/EH-TW480(HC710HD/TW490C), EH-TW420, EH-TW450(HC705HD)

This family uses Infrared communications with the projector (at 38Khz) via a stick-on “bug” IR transmitter placed over the IR window on the back of the projector. This family of projectors all use Device-code 8355h and “NEC” format.

It simulates the IR codes sent by the hand-held remote control, and unfortunately the functions are limited by the projector’s lack of absolute command codes in the IR sequences. Thus there are no absolute commands for “Video”, “Computer 1”, etc: rather the keyboard (Code 1) has a green button marked “Source / On” which sends the “Power” command to the projector once, but does not send a “Set Source” command automatically after warm-up. The red LED comes on immediately on power up with no flashes, and the green LED flashes during warmup and glows continuously in the ON state. Pressing the OFF button sends the “POWER” IR message twice and the red LED blinks during the cool-down time, then glows steadily.

The projector will start on the same source channel it was displaying when switched OFF. Pressing the “Source / On” button again (after warm-up) will index the projector through available sources, but it will only stop on a source if a valid input **is being fed into that input when the projector is looking at that channel**. If there is no input at that point, it will not change to it, but just put up a message screen. If a valid signal is then applied, the “Source / On” button will need to be pressed again to get it to lock onto the new source.

User’s manuals are at: <http://tech.epson.com.au/downloads/index.asp?select=7&sCategory=>

The “Code 1” keyboard provides incremental volume Up/Down keys, and the current volume level is shown on the projected image for a few seconds. **With S6/X6 a separate volume enable IR command is sent, so the volume bar display time is shorter.** There is only one audio input for these.

Operation with the T441/T461 audio mixer (OPT8 On) is provided available but for one channel (Channel 1) only. In an installation using this mode, we suggest a pair of RCA sockets be provided to the user, and the T440 volume keys will correctly control room audio level from these sockets whatever video channel is in use (computer, DVD or VCR). The T441/T461 audio output can then drive the PA or powered speakers. (There is no way the T440 controller knows which video source is in use to command the T441/T461 audio source switching to follow the video source.)

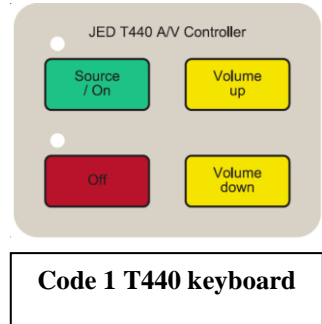

The red and green LEDs follow the current state of the projector. If the projector gets out of step with the controller (eg by the projector being ON when the red OFF led is showing), pressing the ON button will get it back into step, and then pressing OFF once will send the “POWER” IR message twice, with a 1-second separation, leaving both OFF.

Because there is no feedback serial path to the controller, OPT7 status read-back is not possible. (Freeze and mute are not supported. Two-button-mute mode is not supported either.)

**Wiring:** The IR transmitting bug is wired to the IR output socket J2 with the shield of the cable connected to the ground pin and the centre conductor to the “+IR” pin. The signal is current limited (24mA pulses), so no series resistors are needed in the cable.

As the IR bug wire is only 2M long it will usually be extended, and CAT5 cable is OK for this, but it must be via its own twisted pair (colour plus colour-with-white). (We have successfully tested this with 50M of CAT5E cable.)

If the CAT5 connector and cable is used runs from CAT5 connector J6, the IR signal runs via a twisted pair of wires via this cable, but link L1 must be moved from Tx (it’s position in RS232 mode) to IR (as needed for IR mode).

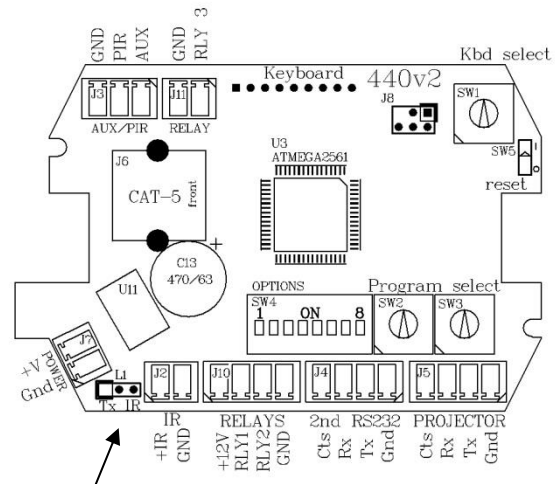

**T430:** If using a T430, the keyboard has an ON/Source key and no Volume keys. The IR functions allow power On/Off and source change only. Operation is the same as above.

If OPT4 is OFF, no source changes occur (for a V1 keyboard).

If OPT4 is ON, then a “source” command is sent with each press of the On / Source key. (V3 keyboard.)

**Code A3:** EB-S03+/W03/X03, EB-W15/+, EB-S17/W17/X17, EB-W18/+, EB-S18/X18/, EB-X24

**Code A4:** This same group, with absolute power On and Off IR commands (undocumented!!)

This family provides more control via IR than the family above, in that there are individual buttons for Computer, Video, USB and LAN. (USB and LAN can be re-mapped to the Computer or Video keys.)

The “A3” driver is suitable for use with the Code 0 (just On/Off Computer and Video), Code 9 (with Volume Up/Down) or Code A (with Mute and Freeze). There is one Computer input, which is selected with the “Computer” key. There are three Video inputs scrolled through with the “Video” key, Video (composite), S-Video, and HDMI.

Option4 switch cannot be used, as the system has to send multiple “Video” commands to scroll through the video options, and cannot use the Toggle function.

```

Input1FunctionCode := $0094; // Computer (default)
Input3FunctionCode := $0070; // Video (default)
Input5FunctionCode := $0074; // LAN
Input6FunctionCode := $0076; // USB
Input7FunctionCode := $008C; // Source Search

```

## HP vp6320/6321/6325, xp8010/8020 (Code 48 ), ep7120/7122 (Code 49 )

Manuals available on line:

HP vp6300 manual: [http://www.projectorcentral.com/pdf/projector\\_manual\\_2885.pdf](http://www.projectorcentral.com/pdf/projector_manual_2885.pdf)

HP ep7120/7122 manual:

<http://h10025.www1.hp.com/ewfrf/wc/document?lc=en&cc=us&docname=c00216274&product=427168&dlc=en&printable=yes&encodeUrl=true&>

HP xp8010 manual: <http://h10032.www1.hp.com/ctg/Manual/bpq04040.pdf>

Channel codes are:

```

Input1 := '*RSRC=1' + 0D; //Computer1 VGA1 Analog RGB DB15 vp632x, xp802x, Code 48
Input2 := '*RSRC=2' + 0D; //Computer2 VGA2 Analog RGB DB15 on xp8010/20, Code 48

Input1 := '*RSRC=8' + 0D; // Computer1 VGA1 Analog RGB via DVI to DB15 adaptor (ep712x, Code 49)

Input3 := '*RSRC=3' + 0D; //Video1 Composite Video RCA all
Input4 := '*RSRC=4' + 0D; //Video2S-Video all
Input5 := '*RSRC=5' + 0D; // Component Video YPbPr xp632x/xp8010/20
Input6 := '*RSRC=6' + 0D; // RGBHV xp8010/20, Code 48
Input7 := '*RSRC=7' + 0D; // M1 Graphics (DVI) xp8010/20, Code 48
Input8 := '*RSRC=8' + 0D; // DVI vp63xx, not analog, Code 48
    
```

Any one of these codes can be set into Constant:0/Constant:1 for computer codes and Constant:2/Constant:3 for video codes. (The default is to have Computer1 (above) as the “Computer” channel and Video1 as the “Video” channel. Setting OPT1 switch ON will swap Video1 and Video2 channels, making S-Video the video default. Setting OPT5 will swap Computer1 and Computer2. Setting OPT4 will allow double- presses on some keyboards.).

- Setting OPT2 switch ON will send an Auto Pixel Align message 30 seconds after selecting a computer channel;
- Pressing a “Computer” channel key when already selected will instead send a Auto Pixel Align whenever needed;
- For ep712x use Code 49 on the Sw2/3, and use DVI-> VGA connector. (No computer 2.)
- OPT7 handshake mode and power on panel connection blink codes available.

## RS232 connections to Hewlett-Packard vp63xx, xp80xx, (probably also ep712x)

These use a 9-pin-D9 male on the proj, female on cable. Comms is at 9600 baud, 8 bits, no parity, and 1 stop.

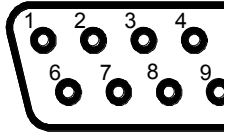
Function/Direction	T440 “projector” Connection	“Serial” Port Connector	
Ground	Ground	9-pin D-sub pin 5	 <p>D-sub 9 female</p>
Data from T440 to projector	Tx	9-pin D-sub pin 2 (RXD)	
Reply data from projector to T440	Rx	9-pin D-sub pin 3 (TXD)	
Plus 9 volt CTS/DTR to projector	N/c		

After installation wiring of any projector to a T440, use a multimeter to check voltages of -9 on BOTH TX and RX pins in any installation, as described in the troubleshooting part of this manual.

## Hitachi projectors (Code 44 , single audio control, Code 45, “by channel” audio)

This family has a compact set of “BE EF” hex commands consistent across the models. Two code groups are provided: Following have **no audio** so can use either code: PJ-TX100, TX200, TX300, CP-X10000, CP-WX11000, CP-SX12000

**Code 44** is used when there is an audio in for typically each RGB channel but one audio shared by all video inputs. There is only one pair of commands for audio Inc/Dec and the level of all channels is controlled by this one pair of commands. So if a level has been dropped for a RGB channel, the audio level is down for the Video input and needs to be manually adjusted up. These are typically many older models (excluding 3-byte code: CP-X935 to X970.)

Also supported by code 44 are: 3M-MP8746/MP8747/MP8775, 3M-X45, 3M-X55, 3M-X75, 3M-X70, 3M-X80, ELMO EDP-S10, ViewSonic PJ510, PJ853, PJ656, PJ552, PJ562, PJ750, PJ862, PJ1165, PJ1172, PJ1065, also InfocusLP800 (Hitachi PJ-TX10 does have Code 44 audio.)

**Code 45** is used when there are a number of audio inputs (2, 3 or 4) but these are unallocated to a video channel. **These must be manually allocated using the projector menu system to suit the audio sources, cables and connectors on site, but any audio input can typically be allocated to any video/RGB input.** Audio channels can be shared or a channel set to have no audio. A typical menu sequence is to go to: Menu -> Advanced menu -> Audio -> Audio, which gives a table of (a variable number of) channel names down the left column, audio inputs by number across the top, and a matrix of buttons which allows one allocation button or an OFF button to be selected per channel. Use the “down” button to select a channel, and the “left” or “right” buttons to move the “dot” to select that channel’s audio. Move to the “quit” position to save and use the “left” to exit the menu.

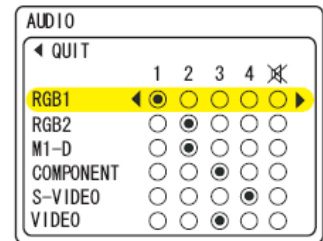

**Typical Code 45 models** are: CP-A52, CP-A100, CP-A200/N, CP-A200, CP-A220N, CP-A300NM,

CP-AW250N/M, CP-AW2503, CP-AW3003,

CP-AX2503, CP-AX3003, CP-AX3503,

CP-CW250WN, CP-CW300WN, CP-CX250, CP-CX300WN

CP-D10, CP-DW10N, CP-D20, CP-D27, CP-D32WN, CP-DW10N, CP-DW25WN,

CP-EW250N, CP-EW300N, CP-EX250N, CP-EX300N,

CP-SX12000, CP-SX635, CP-SX8350,

CP-TW2503, CP-TW3003,

CP-WU8440, CP-WU8450, CP-WUX645N, CP-WU8460,

CP-WX8, CP-WX3530WN, CP-WX8240, CP-WX8255, CP-WX11000, CP-WX3011N, CP-WX3014WN, CP-WX4021N, CP-WX625, CP-WX2515WN, CP-WX3014WN, CP-WX3015WN, CP-WX4022WN, CP-WX8240, CP-WX8255, CP-WX8265,

CP-X2, CP-X4, CP-X6, CP-X8, CP-X9, CP-X200, CP-X201, CP-X205, CP-X206, CP-X251, CP-X253, CP-X245, CP-X255, CP-X256, CP-X260, CP-X265, CP-X268, CP-X300, CP-X301, CP-X305, CP-X306, CP-X308, CP-X400, CP-X401, CP-X417, CP-X450, CP-X505, CP-X600, CP-X605, CP-X608, CP-X615, CP-SX635, CP-X705W, CP-X809, CP-X2010, CP-X2011/N, CP-X2012WN, CP-X2015WN, CP-X2020, CP-X2510, CP-X2511/N, CP-X2514WN, CP-X2515WN, CP-X2520, CP-X2521WN, CP-X3010, CP-X3011/N, CP-X3014WN, CP-X3015WN, CP-X3020, CP-X3511, CP-X4011/N, CP-X4014WN, CP-X4015WN, CP-X4020/E, CP-X4021N, CP-X4022WN, CP-X4030WN, CP-X5021N, CP-X5022WN, CP-X8150, CP-X8160, CP-X8170, CP-X10000,

ED-A100, ED-A101, ED-A110 (A1DN), ED-A111, ED-A220NM, ED-AW100N, ED-AW110N, ED-D10N, ED-D11N, ED-X10, ED-X12, ED-X15, ED-X22, ED-X50, ED-X52, iPJ-A250NM

**ViewSonic:** PJ759/PJ758/PJ760, PJ1158

**3M-X64, 3M-X66, 3M-X76, 3M-X90**

In the back of each user’s manual is a list of typical channel selection messages, and manuals of most Hitachi projectors are available at: <http://www.projectorcentral.com/Hitachi.htm> or <http://www.hitachi.com/products/personal/av.html>

Channel codes are:

Input1 := BE + EF + 03 + 06 + 00 + FE + D2 + 01 + 00 + 00 + 20 + 00 + 00; //Computer1 RGB 1 DB15  
 Input2 := BE + EF + 03 + 06 + 00 + 3E + D0 + 01 + 00 + 00 + 20 + 04 + 00; //Computer2 RGB 2 DB15 or BNC

Input3 := BE + EF + 03 + 06 + 00 + 6E + D3 + 01 + 00 + 00 + 20 + 01 + 00; //Video1 Composite Video RCA

\*(OPT1 swaps Video1 & Video2)

Input4 := BE + EF + 03 + 06 + 00 + 0E + D2 + 01 + 00 + 00 + 20 + 03 + 00; //Video2 Digital/M1D/DVI/HDMI  
 \*(OPT1 swaps Video1 & Video2)

\*T440: OPT6 switch ON will use S-Video in place of HDMI/DVI. T430: Uses HDMI for Video2

Input4 := BE + EF + 03 + 06 + 00 + 9E + D3 + 01 + 00 + 00 + 20 + 02 + 00; //Video2 S-Video\*  
 Input5 := BE + EF + 03 + 06 + 00 + AE + D1 + 01 + 00 + 00 + 20 + 05 + 00; // Y, Pb/Cb, Cb/Cr (Component)  
 Input6 := BE + EF + 03 + 06 + 00 + CE + D0 + 01 + 00 + 00 + 20 + 07 + 00; // BNC CPWX11000  
 Input7 := BE + EF + 03 + 06 + 00 + AE + D4 + 01 + 00 + 00 + 20 + 09 + 00; // DVI-D  
 Input8 := BE + EF + 03 + 06 + 00 + CE + D5 + 01 + 00 + 00 + 20 + 0B + 00; // LAN  
 Input9 := BE + EF + 03 + 06 + 00 + 0E + D2 + 01 + 00 + 00 + 20 + 03 + 00; // Digital/M1D/DVI/HDMI  
 Input10 := BE + EF + 03 + 06 + 00 + 6E + D6 + 01 + 00 + 00 + 20 + 0D + 00; // HDMI 2  
 Input11 := BE + EF + 03 + 06 + 00 + AE + DE + 01 + 00 + 00 + 20 + 11 + 00; // HDBaseT  
 Input12 := BE + EF + 03 + 06 + 00 + 5E + D1 + 01 + 00 + 00 + 20 + 06 + 00; // USB A  
 Input13 := BE + EF + 03 + 06 + 00 + FE + D7 + 01 + 00 + 00 + 20 + 0C + 00; // USB B  
 Input14 := BE + EF + 03 + 06 + 00 + 5E + DE + 01 + 00 + 00 + 20 + 12 + 00; // SDI  
 Input15 := BE + EF + 03 + 06 + 00 + CE + DF + 01 + 00 + 00 + 20 + 13 + 00; // DisplayPort

Any one of these codes can be set into Constant:0/Constant:1 for computer codes and Constant:2/Constant:3 for video codes. (The default is to have Computer1 (above) as the “Computer” channel and Video1 as the “Video” channel. Setting OPT1 switch ON will swap Video1 and Video2 channels, making S-Video the video default. Setting OPT5 will swap Computer1 and Computer2. Setting OPT4 will allow double- presses on some keyboards.).

- OPT7 handshake mode and power on panel connection blink codes available.
- Absolute Freeze and Mute are supported, so Code A keyboards are supported.
- T441/T461 audio is supported, with video and audio mute supported.

### Aspect ratio setting for Hitachi family

The aspect ratio codes for all Hitachi projectors are covered here, but are interpreted differently with different models. Note that to use these, enable bits for ratios usable by each channel must be set into UserFlags[0..3] and the preselected or “default” aspect setting must be set into UserFlags[5..8] The functions provided are as follows:

SetAspect1 := BE + EF + 03 + 06 + 00 + FE + D1 + 01 + 00 + 08 + 20 + 02 + 00; // Small 4:3 (some).  
 SetAspect2 := BE + EF + 03 + 06 + 00 + 9E + D0 + 01 + 00 + 08 + 20 + 00 + 00; // Regular 4:3  
 SetAspect3 := BE + EF + 03 + 06 + 00 + 0E + D1 + 01 + 00 + 08 + 20 + 01 + 00; // 16:9  
 SetAspect4 := BE + EF + 03 + 06 + 00 + 3E + D6 + 01 + 00 + 08 + 20 + 0A + 00; // 16:10  
 SetAspect5 := BE + EF + 03 + 06 + 00 + CE + D6 + 01 + 00 + 08 + 20 + 09 + 00; // 14:9  
 SetAspect6 := BE + EF + 03 + 06 + 00 + 5E + D7 + 01 + 00 + 08 + 20 + 08 + 00; // Native/Real  
 SetAspect7 := BE + EF + 03 + 06 + 00 + 5E + DD + 01 + 00 + 08 + 20 + 10 + 00; // Normal

(Note that initial aspect ratio commands do not appear to be accepted if there is no signal input to that channel.)

### RS232 connections to Hitachi and 3M, InFocus and Elmo Hitachi-made projectors

These use either a D-sub 15 shrink jack pin connector, female on cable, or a DB9, female on cable.

**Coms at 19200 8N1 (Note: this may have to manually set up in the projector):**

Function/ Direction	T440 “projector” Connection	Hitachi “Control” Port Connector 15-pin shrink	Hitachi “Control” Port Connector, DB9 (some)
Ground	Ground	Pin 6, 7 and 10. (Use all)	Pin 5
Data from T440 to projector	Tx	Pin 13	Pin 2
Reply data from proj. to T440	Rx	Pin 14	Pin 3
Plus 9 volt CTS/DTR	N/C	N/C	N/C

After installation wiring of any projector to a T440, use a multimeter to check voltages of –9 on BOTH TX and RX pins in any installation, as described in the troubleshooting part of this manual. CTS is NOT needed.

## Hitachi projector (Code 46 , at 115200 baud)

### CP-DH300 (BenQ type codes)

Channel codes are:

```
Input1 := 0D + '(sour=RGB)' + 0D; //Computer1 Analog RGB1 DB15 inc YPbPr
Input2 := 0D + '(sour=RGB2)' + 0D; //Computer2 Analog RGB2 DB15 inc YPbPr2
Input3 := 0D + '(sour=vid)' + 0D; //Video1 Composite Video RCA *(OPT1 swaps Video1 & Video2)
Input4 := 0D + '(sour=hdmi)' + 0D; //Video2 HDMI *(OPT1 swaps Video1 & Video2)
```

\*T440: OPT6 switch ON will use S-Video in place of HDMI/DVI. T430: Uses HDMI for Video2

```
Input4 := 0D + '(sour=svid)' + 0D; //Video2 S-Video
```

Any one of these codes can be set into Constant:0/Constant:1 for computer codes and Constant:2/Constant:3 for video codes. (The default is to have Computer1 (above) as the “Computer” channel and Video1 as the “Video” channel. Setting OPT1 switch ON will swap Video1 and Video2 channels, making HDMI the video default. Setting OPT5 will swap Computer1 and Computer2. Setting OPT4 will allow double-presses on some keyboards.).

- On panel connection blink codes and OPT7 handshake mode are provided;
- Two-yellow button “Mute” and “Blank” command is supported; and
- Turn off “Quick auto search” in the third menu.
- Set “Auto Power Off to “Disable”

### Aspect ratio setting for this Hitachi family

Note that to use these, enable bits for ratios usable by each channel must be set into UserFlags[0..3] and the preselected or “default” aspect setting must be set into UserFlags[5..8] The functions provided are as follows:

```
SetAspect1 := 0D + '(asp=4:3)' + 0D; // Reg 4:3
SetAspect2 := 0D + '(asp=16:9)' + 0D; // 16:9
```

### RS232 connections to Hitachi with D9

These use a 9-pin-D9 male on the proj, female on cable. Comms is at 115200 baud (not adjustable), 8 bits, no parity, 1 stop.

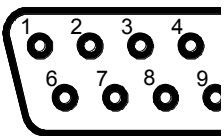
Function/Direction	T440 “projector” Connection	“Serial” Port Connector	 <p>D-sub 9 female</p>
Ground	Ground	9-pin D-sub pin 5	
Data from T440 to projector	Tx	9-pin D-sub pin 2 (RXD)	
Reply data from projector to T440	Rx	9-pin D-sub pin 3 (TXD)	
Plus 9 volt CTS/DTR to projector	n/c	n/c	

**After installation wiring of any projector to a T440, use a multimeter to check voltages of –9 on BOTH TX and RX pins in any installation, as described in the troubleshooting part of this manual.**

## InFocus projectors (Code 1F ) (at 9600 baud)

IN11x, IN12x, IN12xST, IN212x (eg IN126)

Control codes are at:

[http://www.infocus.com/sites/default/files/SupportDocs/InFocus\\_IN120\\_Projector\\_Series/InFocus\\_IN126\\_Projector/IN12x\\_RS232\\_Commands.pdf](http://www.infocus.com/sites/default/files/SupportDocs/InFocus_IN120_Projector_Series/InFocus_IN126_Projector/IN12x_RS232_Commands.pdf)

Channel codes are:

```
Input1 := '(SRC0)'; //Computer1 "Computer 1", DSUB15 VGA
Input2 := '(SRC1)'; //Computer2 "Computer 2", DSUB15 VGA

Input3 := '(SRC2)'; //Video1 "Composite", RCA Composite *(OPT1 swaps Video1 & Video2)
Input4 := '(SRC4)'; //Video2 HDMI *(OPT1 swaps Video1 & Video2)
```

\*T440: OPT6 switch ON will use S-Video in place of HDMI/DVI. T430: Uses HDMI for Video2

```
Input4 := '(SRC3)'; //Video2 S-Video
Input5 := '(SRC4)'; //HDMI
```

Any one of these codes can be set into Constant:0/Constant:1 for computer codes and Constant:2/Constant:3 for video codes. (The default is to have Computer1 (above) as the “Computer” channel and Video1 as the “Video” channel. Setting OPT1 switch ON will swap Video1 and Video2 channels, making HDMI the video default. Setting OPT5 will swap Computer1 and Computer2. Setting OPT4 will allow double-presses on some keyboards.).

- On panel connection blink codes and OPT7 handshake mode are available;
- Freeze command is NOT available, so “Code 8 or A” keyboards are NOT OK;
- Two-yellow button “Mute” and “Blank” command is supported;
- The projector is set to Auto Source = 0 (Off) automatically from the T440 by a command string; and
- There is about a 10 second delay after pressing OFF before the lamp goes out and “Cooldown” starts.

### Aspect ratio setting for InFocus family

The aspect ratio codes for all InFocus projectors are the same, but are interpreted differently with different models. Note that to use these, enable bits for ratios usable by each channel must be set into UserFlags[0..3] and the preselected or “default” aspect setting must be set into UserFlags[5..8] The functions provided are as follows:

```
SetAspect1 := '(ARZ1)'; // Native
SetAspect2 := '(ARZ2)'; // 4:3
SetAspect3 := '(ARZ3)'; // 16:9
SetAspect4 := '(ARZ4)'; // Letterbox
SetAspect5 := '(ARZ6)'; // 16:10
```

(Note that initial aspect ratio commands do not appear to be accepted if there is no signal input to that channel.)

### RS232 connections to InFocus with D9

These use a 9-pin-D9 male on the proj, female on cable. Comms is at 9600 baud (not adjustable), 8 bits, no parity, 1 stop.

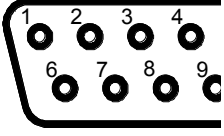
Function/Direction	T440 “projector” Connection	“Serial” Port Connector	 <p>D-sub 9 female</p>
Ground	Ground	9-pin D-sub pin 5	
Data from T440 to projector	Tx	9-pin D-sub pin 2 (RXD)	
Reply data from projector to T440	Rx	9-pin D-sub pin 3 (TXD)	
Plus 9 volt CTS/DTR to projector	n/c	n/c	

**After installation wiring of any projector to a T440, use a multimeter to check voltages of –9 on BOTH TX and RX pins in any installation, as described in the troubleshooting part of this manual.**

## InFocus projectors (Code 58 ) (also some ASK/Proxima) (at 19200 baud)

**IN2100 series:** IN2102/EP, IN2104/EP and IN2106/EP, IN2112, IN2114, IN2116, A1100, A1200/EP, A1300, IN25, IN27/W, C212 and C214.

**IN3100 series:** IN3102, IN3104, IN3106, IN3108, IN3114, IN3116, IN3182, IN3184, IN3186, IN3188, A3100, A3180, A3200, A3280, A3300 and A3380. (Untested)

In the back of each user's manual is a list of typical channel selection messages, and manuals of InFocus projectors are available at: <http://www.infocus.com/support.aspx>, enter projector model number into the "Projector QuickFind" window to get to an individual model's page, and click the "documents" tab for codes.

Channel codes are:

```
Input1 := '(SRC0)'; //Computer1 DSUB1 VGA analog-RGB IN2100 series, unknown IN3100 family
Input2 := '(SRC1)'; //Computer2 DSUB2 VGA analog-RGB IN2100 series, unknown IN3100 family

Input3 := '(SRC3)'; //Video1 Comp Video IN2100 series, unknown IN3100 family
Input4 := '(SRC2)'; //Video2 S-Video IN2100 series, unknown IN3100 family

Input5 := '(SRC4)'; //Liteport (some) Unknown allocation IN3100 family
```

Any one of these codes can be set into Constant:0/Constant:1 for computer codes and Constant:2/Constant:3 for video codes. (The default is to have Computer1 (above) as the "Computer" channel and Video1 as the "Video" channel. Setting OPT1 switch ON will swap Video1 and Video2 channels, making S-Video the video default. Setting OPT5 will swap Computer1 and Computer2. Setting OPT4 will allow double-presses on some keyboards.)

**Important notes:** You MUST power up the projector manually and setup the following options:

Press **Menu**, the **Down Arrow** twice, then **Right Arrow** once to enter **Setup** menu. In **Setup** use the **Down Arrow** to go to **Always-On Functions** and set **Network** to **Yes** (This enables RS232 coms in standby so the ON command works.) Also, this driver assumes that **Command Echo is set to OFF** (also set in "Setup" menu). If this is not done, the initial blink codes and OPT7 handshake will not work.

While in this menu, make sure **Auto Source** is turned to **Off**.

Also, you must set the **Serial Port Baud Rate** to **19200**

- The current 2100 projectors supplied in Australia **MUST HAVE A SOFTWARE UPGRADE BEFORE INSTALLATION from 1.01 to 1.07 or later**, otherwise operation is unreliable (comms hangs up) and handshake response requests are incorrectly interpreted as a "power down" command, due to a firmware bug in the projector. (Rev 02.06.00 is current shipping in Jan 2011);
- On panel connection blink codes and OPT7 handshake mode are available;
- Freeze command is available, so "Code 8 or A" keyboards are OK;
- Two-yellow button "Mute" command is supported;
- The projector is set to Auto Source = 0 (Off) automatically from the T440 by a command string; and
- There is about a 10 second delay after pressing OFF before the lamp goes out and "Cooldown" starts.

### Aspect ratio setting for InFocus family

The aspect ratio codes for all InFocus projectors are the same, but are interpreted differently with different models. Note that to use these, enable bits for ratios usable by each channel must be set into UserFlags[0..3] and the preselected or "default" aspect setting must be set into UserFlags[5..8] The functions provided are as follows, with functions for the IN2116 family:

```
SetAspect1 := '(ARZ1)'; // Native (small) (or 16:9 on some)
SetAspect2 := '(ARZ2)'; // 4:3
SetAspect3 := '(ARZ3)'; // 16:9
SetAspect4 := '(ARZ4)'; // Letterbox
SetAspect5 := '(ARZ5)'; // Panorama
SetAspect6 := '(ARZ6)'; // Fullscreen / 16:10
```

(Note that initial aspect ratio commands do not appear to be accepted if there is no signal input to that channel.)



## RS232 connections to InFocus with D9

These use a 9-pin-D9 male on the proj, female on cable. Comms is at 19200 baud (after setting), 8 bits, no parity, 1 stop.

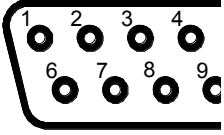
Function/Direction	T440 "projector" Connection	"Serial" Port Connector	 D-sub 9 female
Ground	Ground	9-pin D-sub pin 5	
Data from T440 to projector	Tx	9-pin D-sub pin 2 (RXD)	
Reply data from projector to T440	Rx	9-pin D-sub pin 3 (TXD)	
Plus 9 volt CTS/DTR to projector	n/c	n/c	

After installation wiring of any projector to a T440, use a multimeter to check voltages of -9 on BOTH TX and RX pins in any installation, as described in the troubleshooting part of this manual.

### InFocus projectors LP\*\*\* models (Code 59, 5A, 5B, 6A )

LP540, LP640, LP600, LP815, LP820, LP840, LP850, LP860 ... Code 59 .

LP650 ... Code 5A .

LP500, LP530 ... Code 5B .

LP790 ... Code 6A .

In the back of each user's manual is a list of typical channel selection messages, and manuals of InFocus projectors are available at: <http://www.infocus.com/support.aspx> , enter projector model number into the "Projector QuickFind" window to get to an individual model's page, and click the "documents" tab for codes.

Channel codes for **LP540, LP640, LP600, LP815, LP820, LP840, LP850, LP860** ... Code 59 are:

```

Input1 := '(SRC1)' //Computer1 "Computer 2", DSUB15 VGA
Input2 := '(SRC0); //Computer2 "Computer 1", M1 D/A (DVI)

Input3 := '(SRC4); //Video1 "Video 2", RCA Composite
Input4 := '(SRC3); //Video2 "Video 1", S-Video

Input5 := '(SRC5); // Component / Computer 3 RGB-HV BNC
Input6 := '(SRC6); // Video 1 RGB
Input7 := '(SRC2); // "Computer 3" RGB / "Video 1" Component 3 RCA
  
```

Channel codes for **LP650** ... Code 5A are:

```

Input1 := '(SRC1); //Computer1 "Computer 2", DSUB15 VGA
Input2 := '(SRC0); //Computer2 "Computer 1", M1 D/A (DVI)

Input3 := '(SRC3); //Video1 "Video 2", RCA Composite
Input4 := '(SRC2); //Video2 "Video 1", S-Video

Input5 := '(SRC4); // "Video 3" Component 3 RCA
  
```

Channel codes for **LP500, LP530** ... Code 5B :

```

Input1 := '(SRC2)' //Computer1 DSUB15 VGA
Input2 := '(SRC0); //Computer2 "Computer 1", M1-A (DVI-A)

Input3 := '(SRC5); //Video1 "Video 2", RCA Composite
Input4 := '(SRC4); //Video2 "Video 1", S-Video

Input5 := '(SRC3); // "Video 3" Component 3 RCA
Input6 := '(SRC6)' // PC2 Component
Input7 := '(SRC7)' // PC2 VESA
Input8 := '(SRC1); // M1 DVI-D
  
```

Channel codes for **LP790** ... Code 6A . (Note: Set baud rate to 19200 manually)

```

Input1 := '(SRC0); //Computer1 "VGA 1", DSUB15 VGA
Input2 := '(SRC3); //Computer2 "VGA 2", DSUB15 VGA

Input3 := '(SRC2); //Video1 "CVBS1", RCA Composite
Input4 := '(SRC1); //Video2 "S-VIDEO1", S-Video
  
```

```

Input5 := '(SRC5); // "CVBS2" RCA Composite
Input6 := '(SRC6); // "DVI1"
Input7 := '(SRC7); // "DVI2"
Input8 := '(SRC8); // "BNC1"
Input9 := '(SRC9); // "BNC2"
Input10 := '(SRC4); // "S-VIDEO2"

```

Any one of these codes can be set into Constant:0/Constant:1 for computer codes and Constant:2/Constant:3 for video codes. (The default is to have Computer1 (above) as the “Computer” channel and Video1 as the “Video” channel. Setting OPT1 switch ON will swap Video1 and Video2 channels, making S-Video the video default. Setting OPT5 will swap Computer1 and Computer2. Setting OPT4 will allow double-presses on some keyboards.).

- On panel connection blink codes and OPT7 handshake mode are available;
- Freeze command is available, so “Code 8 or A” keyboards are OK;
- Two-yellow button “Mute” command is supported;
- The projector is set to Auto Source = 0 (Off) automatically from the T440 by a command string; and
- There is about a 10 second delay after pressing OFF before the lamp goes out and “Cooldown” starts.

RS232 connections to InFocus Models: LP540, LP640, LP600, LP815, LP820, LP840, LP850, LP860, LP650, LP500, LP530, LP790

These use a 9-pin-D9 male on the proj, female on cable. Comms is at 19200 baud, 8 bits, no parity, 1 stop.

**Some may need to be manually set to 19200.**

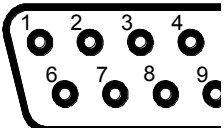
Function/Direction	T440 “projector” Connection	“Serial” Port Connector	 <p>D-sub 9 female</p>
Ground	Ground	9-pin D-sub pin 5	
Data from T440 to projector	Tx	9-pin D-sub pin 2 (RXD)	
Reply data from projector to T440	Rx	9-pin D-sub pin 3 (TXD)	
Plus 9 volt CTS/DTR to projector	n/c	n/c	

**After installation wiring of any projector to a T440, use a multimeter to check voltages of –9 on BOTH TX and RX pins in any installation, as described in the troubleshooting part of this manual.**

## Mitsubishi projector families: Codes 23 to 2A

In the back of some user manuals is a list of RS232 control messages.

Also, see master RS232 code list at: <http://www.mitsubishi-presentations.com/product-support/downloads/controlcodes/>

(See also “Deleted” tab codes on link on this page.)

Volume range settings determine what codes family to select: Audio is done either with an “Absolute” command, “00VL” followed by a decimal 2-digit number, eg “00VL21<CR>”, or an increment/decrement command “00r06<CR>” and “00r07<CR>”.

For the absolute volume controlled projectors, there is a paragraph in the manual section or document called “Controlling the projector using a personal computer” called “Volume Commands”. Look in there for the volume range, eg **00 – 31** in the box after the VL command definition. Select a control code from the following table:

Volume range	Code group on hex switches	Volume range	Code group on hex switches
00-21	24	00-60	26
00-31	25	00-100	27
00-32	29		

**Note: We found some Mit. Projectors have different audio control ranges than the Mit. manual states. If you cannot get the full volume range, try a different code.**

**Group 23 LED/LASER:** NW30U, NW31U/EST, NF32U: short warmup-closedown, fast channel change, 0->21 volume.

### Some model types for code group 24 , 00-21 range:

EX10U, EX53U/E, ES-EX100U, FD630U/G, FD730U/G, HC100, SD220U, S/XD221, S/XD420U, S/XD430U, HC900/E, UD740U, WD380U-EST, WD385U-EST, WD390U/EST, WD500U-ST, WD510U, WD510U-G, WD570U, WD720U, WD2000, WL639U, XD250U, XD250XD, XD280U, XD360U-EST, XD365U-EST, WD380U/EST, WD385U/EST, XD435U, XD400U, XD450U, XD460U, XD470U, XD480U, XD490U, XD500, XD510U, XD520U, XD530U/E, XD550U, XD560U, WD570U, XD700U, XD2000U, XL6U.

### Some model types for code group 25 , 00-31 range:

FL6900, FL7000U, HD8000, MH2850U, UL7400, WL2560U, WL7050U, WL7200U, WL6700U/LU, S/XL4U, XL5U, SL6U, XL8U, XL9U, S/XL25U, XL30U, X200E, S/XD200U, XD300U, XD350U, X390U, X400U, SX490U, X500U, XL550U, XD550U, XD650U, XL650U, XL1550U, XL2550U, XL5900U, XL5950U, XL5980U/LU, XL6500U/LU, XL6600U/LU, XL7100 InFocus LP1200

### Some model types for code group 26 , 00-60 range:

S/XL1U, S/XL2U, S/X50U, SA51U, X70U, X80U

### Some model types for code group 27 , 00-100 range:

SD105U, S/XD206U:

### Some model types for code group 28 , no audio or inc/dec \*3 audio only range:

If there is no “Volume commands” paragraph (or no audio in the projector), use the incremental control driver selection, code 28 .

No audio: HC1100, HC1500, HC1600, HC3000, HC3100, HC3800, HC4900, HC5000, HC5500, HC6000, HC6500, HC6800, HC7000, HD1000, HD4000, UD8400U, WD8200U/LU

Inc/dec audio: X100E, S/X120E, S/X250U, S290U, X300U

### Some model types for code group 2A , inc/dec by 1's:

EW330U/ST, EW331U/ST, EX241U, EX320U/ST, EX321U/ST (projector audio range is 0->10) no absolute volume )

**Channel codes are:**

```

Input1 := '00_r1' + 0D; //Computer1 RGB 1 VGA analog-RGB
Input2 := '00_r2' + 0D; //Computer2 RGB 2 VGA analog, sometimes DVI analog

Input3 := '00_v1' + 0D; //Video1 Vid composite 1 or S-Video 1 * (OPT1 swaps Video1 & Video2)
Input4 := '00_d1' + 0D; //Video2 Vid DVI or HDMI * (OPT1 swaps Video1 & Video2)
    
```

\* T440: OPT6 switch ON will use S-Video in place of HDMI/DVI. T430: Uses HDMI for Video2

```

Input4 := '00_v2' + 0D; //Video2 Vid composite 2 or S-Video 2 *
Input5 := '00_c1' + 0D; // Component

Input6 := '00_d1' + 0D; // DVI or HDMI
Input7 := '00_d2' + 0D; // DVI or HDMI
Input8 := '00_d3' + 0D; // DVI or HDMI

Input9 := '00_n1' + 0D; // Network
    
```

Any one of these codes can be set into Constant:0/Constant:1 for computer codes and Constant:2/Constant:3 for video codes. (The default is to have Computer1 (above) as the “Computer” channel and Video1 as the “Video” channel. Setting OPT1 switch ON will swap Video1 and Video2 channels, making S-Video the video default.

Setting OPT5 will swap Computer1 and Computer2. Setting OPT4 will allow double- presses on some keyboards.).

- OPT7 handshake mode and power on panel connection blink codes available.

**RS232 connections to Mitsubishi projectors (see also D9 following)**

These use an 8 or 9-pin mini-DIN male on the cable. Comms is at 9600 baud, 8 bits, no parity, and 1 stop.

Function/Direction	T440 “projector” Connection	“Serial” Port Connector
Ground	Ground	8 or 9-pin mini-DIN pin 4
Data from T440 to projector	Tx	8 or 9-pin mini-DIN pin 1 (RXD)
Reply data from projector to T440	Rx	8 or 9-pin mini-DIN pin 7 (TXD)
Plus 9 volt CTS/DTR to projector	N/C	N/C

**NOTE: Mitsubishi use either an 8 or a 9-pin connector for RS232 (the 9-pin one has some USB lines, which are ignored in use with the T440). Mitsubishi in some cases supply an off-the-shelf mini-DIN 8 to DB9 and a mini-DIN 9 to DB9 cable called by them the “RS232C” cable.**

After installation wiring of any projector to a T440, use a multimeter to check voltages of -9 on BOTH TX and RX pins in any installation, as described in the troubleshooting part of this manual.

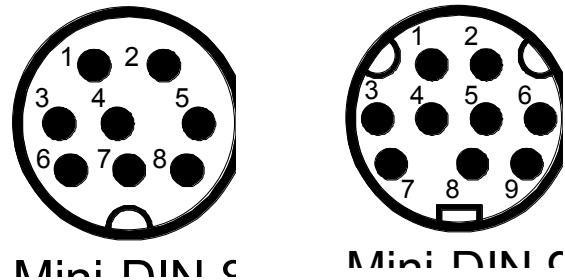

**RS232 connections to Mitsubishi projectors, D9**

These use a 9-pin-D9 male on the proj, female on cable. Comms is at 9600 baud, 8 bits, no parity, and 1 stop.

Function/Direction	T440 “projector” Connection	“Serial” Port Connector
Ground	Ground	9-pin D-sub pin 5
Data from T440 to projector	Tx	9-pin D-sub pin 2 (RXD)
Reply data from projector to T440	Rx	9-pin D-sub pin 3 (TXD)
Plus 9 volt CTS/DTR to projector	N/c	

**D-sub 9 female**

After installation wiring of any projector to a T440, use a multimeter to check voltages of -9 on BOTH TX and RX pins in any installation, as described in the troubleshooting part of this manual.

## Mitsubishi BenQ-style codes: ES200U, EX200U, EW230U, EW270U, EX240U (Code 2B )

Channel codes for these are:

```
Input1 := 0D + '*sour=RGB#' + 0D; //Computer1 Analog RGB DB15
Input2 := 0D + '*sour=RGB2#' + 0D; //Computer2 Analog RGB DB15 no 2

Input3 := 0D + '*sour=vid#' + 0D; //Video1 Composite Video RCA (OPT1 swaps Video1 & Video2)
Input4 := 0D + '*sour=hdmi #' + 0D; //Video 2 DVI-D (Digital)* (OPT1 swaps Video1 & Video2)
```

\* T440: OPT6 switch ON will use S-Video in place of HDMI/DVI. T430: Uses HDMI for Video2

```
Input4 := 0D + '*sour=svid#' + 0D; //Video2 S-Video*
Input8 := 0D + '*sour=hdmi#' + 0D; // HDMI <<<< Note number 8, not 5
```

Any one of these codes can be set into Constant:0/Constant:1 for computer codes and Constant:2/Constant:3 for video codes. (The default is to have Computer1 (above) as the “Computer” channel and Video1 as the “Video” channel. Setting OPT1 switch ON will swap Video1 and Video2 channels, making S-Video the video default. Setting OPT5 will swap Computer1 and Computer2. Setting OPT4 will allow double- presses on some keyboards.).

- Power on panel connection blink codes available, OPT7 handshake mode is NOT;
- Source scan must be turned off using normal on-screen menu options;
- RS232 communications is fixed at 115200 baud. Because of this high communications speed, use shielded cables, or if CAT5 cable, the active TX and RX lines are properly paired with grounds, grounded at BOTH ends;
- Audio functions on some are limited to one audio input (shared by both RGB channels, Video and S-Video) plus HDMI audio and an output which is controlled. (Use a T441/T461 if more audio control is needed;)
- Freeze and mute are absolute in these projectors, and 2-yellow-button mute mode is supported both from the projector and when running with a T441/T461 doing audio control.

## RS232 connections to Mitsubishi projectors with D9

These all use a D-sub 9-pin connector, female on projector, male on cable. Communications runs at 115200 8N1.

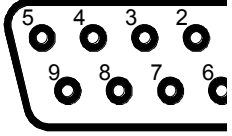
Function/Direction	T440 “projector” Connection	Projector Connector (Male on cable)	
Ground	Ground	9-pin D-sub pin 5	 <p>D-sub 9 mal</p>
Data from T440 to projector	Tx	9-pin D-sub pin 2 (RXD)	
Reply data from projector to T440	Rx	9-pin D-sub pin 3 (TXD)	
Plus 9 volt CTS/DTR to projector	N/C	N/C	

After installation wiring of any projector to a T440, use a multimeter to check voltages of -9 on BOTH TX and RX pins in any installation, as described in the troubleshooting part of this manual.

## NEC projector families: 38,400 baud, Code 10, 13, 14, 15

**NEC 38400 baud, no audio: Code 10** HT1000, HT1100 (fixed 38400), LT25/LT30/LT35, NP40/NP50/NP60, NP41/NP51/NP61/NP62, NP43/NP54/NP63/NP64, NP110/NP115/NP210/NP215. Different Component code: HT410/HT510, LT180, LT75Z, PH1000U, PX700W, PX750U, PX800X, V230, V230X, V260, VT37, VT46/VT460/VT465/VT560/VT660, VT47/VT470/VT570/VT575/VT670/VT676, VT48/VT57/VT58

**NEC 38400 baud, with audio (0-62): Code 10** GT950, GT1150/GT2150, GT5000/GT6000(fixed 38400), LT85/LT150, LT154/LT155/LT156, LT157/LT158, LT280/LT380,

MT840/MT1040/G/MT1045/G(fixed 38400), MT850/MT1050/MT1055, MT1056, MT860/MT1060/MT1065/MT1075,

NP901W/NP905, NP1000/NP2000, NP1150/NP2150/NP3150/NP3151W, NP1250/NP2250/NP3250, NP4000/NP4001, NP4100/W, V260W, V260X, V300X, V300W, VT440/VT540 (fixed 38400), VT770, VT800

**NEC 38400 baud, with audio (0-31): Code 13** LT220/LT240/LT260, LT245/LT265, M230X/M260W/M260X/M300W, M271W/X, M311W/X, M361X, M300W, M300X, M350X, MW420X, MW420XV, NP216, P350W/X, P401W, P420, P451W, P451X, P501X, PA500U, PA500X, PA550W, PA600X, PE401H, U250X, U260W, U300X, U310W, UM280/330X UM280W/X, UM330W/X, V281W, V311W, V311X, VE280/X, VE281/X, VE282/X, WT600, WT610/WT615

**NEC 38400 baud, with audio (0-31): Code 14** PA521U, PA522U, PA571W, PA572W, PA621U/X, PA622U/X, PA671W, PA672W, PA721X, PA722X.

(This group has a 5xBNC connector panel where RGB (2), Composite Video and Y/C video all share one connector group. If Composite video or Y/C (S-video) uses these, you lose RGB usage. Use code 15 (next) to replace Computer 2 with new code for HDMI2.) Code 14/15 uses new HDMI 1 code for Video 2.

PX602UL-WH, -BK, -WL, -BK have BNC as Computer 2, but only one HDMI (new code)

**NEC 38400 baud, with audio (0-31): Code 15** M282X, M302WS, M322W/X, M332X/XS, M352WS, M362W/X, M402W/X, M403, M362X/W, NP-PA803U, NP-PA723U, NP-PA653U, NP-PA853W, NP-PA703W, NP-PA903X

(This group has no RGB (2), so use code 15 to replace Computer 2 with new code for HDMI2.) Code 14/15 uses new HDMI 1 code for Video 2.

## NEC projector families: 19,200 baud, Code 11

**NEC 19200 baud, with audio (0-62):** NP300/NP305/NP310/NP405/NP410/W/NP510/W/WS/NP610/S, NP400/NP500/W/NP600, NP1200, NP2200, NP3200

VT45, VT49/VT59/VT490/VT590, VT480/VT580, VT595/VT695/VT700, VT650,

**Canon 19200 baud, (audio status unknown)**

LV-7240/LV-7245/LV-X5, LV-7250/LV-X6, LV-7255, LV-7260/LV-7265/LV-X7

---

## NEC projector families: 9,600 baud Code 12

**NEC 9600 (fixed) baud, no audio:** LT84/LT140

**9600, Code 12** is also useful for long-line communications to above projectors with alterable baud rates.

For models that don't control audio via RS232: use a T441/461 instead.

(V063 sends PowerOff command at 2 second intervals on OFF press, because NEC sometimes misses command.)

**Note: Check the projector installation guide/user manual and set hex code to match projector speed.**

In the back of each "Installation Guide" is a list of typical channel selection messages. **This also shows baud rate.**

Also, see master NEC code list at: <http://www.nec-display-solutions.co.uk/c/g/uk/en/Service/Home/index.html>  
[http://necvisualsystems.com/cms/documents/UserManuals/RS232\\_PJ\\_ControlCommands.pdf](http://necvisualsystems.com/cms/documents/UserManuals/RS232_PJ_ControlCommands.pdf)

Channel codes are:

Input1 := 02 + 03 + 00 + 00 + 02 + 01 + 01 + 09; //Computer1 RGB 1 VGA analog-RGB  
Input2 := 02 + 03 + 00 + 00 + 02 + 01 + 02 + 0A; //Computer2 RGB 2 sometimes DVI analog

(Input2 := 02 + 03 + 00 + 00 + 02 + 01 + A2 + AA; // HDMI 2 new string, code 14/15)

```

Input3 := 02 + 03 + 00 + 00 + 02 + 01 + 06 + 0E; //Video1* Comp Video (OPT1 swaps Video1 & Video2)
Input4 := 02 + 03 + 00 + 00 + 02 + 01 + 1A + 22; //Video2* HDMI 1 or DVI Digital OR component
(VT770) (OPT1 swaps Video1 & Video2)

(Input4 := 02 + 03 + 00 + 00 + 02 + 01 + A1 + A9; // HDMI 1 new string, code 14/15)

* T440: OPT6 switch ON will use S-Video in place of HDMI/DVI 1 T430: Uses HDMI 1 for Video2

Input4 := 02 + 03 + 00 + 00 + 02 + 01 + 0B + 13; //Video2 S-Video *

Input5 := 02 + 03 + 00 + 00 + 02 + 01 + 07 + 0F; // Comp Video 2
Input6 := 02 + 03 + 00 + 00 + 02 + 01 + 0C + 14; // S-Video 2

Input7 := 02 + 03 + 00 + 00 + 02 + 01 + 10 + 18; // Component #1
Input8 := 02 + 03 + 00 + 00 + 02 + 01 + 11 + 19; // Component #2
Input9 := 02 + 03 + 00 + 00 + 02 + 01 + 12 + 1A; // Component #3

Input10 := 02 + 03 + 00 + 00 + 02 + 01 + 1A + 22; // HDMI or DVI Digital OR component (VT770)
Input11 := 02 + 03 + 00 + 00 + 02 + 01 + 03 + 0B; // DVI Analog
Input12 := 02 + 03 + 00 + 00 + 02 + 01 + 1F + 27; // Input Select Viewer
Input13 := 02 + 03 + 00 + 00 + 02 + 01 + 20 + 28; // LAN

Input14 := 02 + 03 + 00 + 00 + 02 + 01 + 24 + 2C; // Slot1-1 GT5000/6000
Input15 := 02 + 03 + 00 + 00 + 02 + 01 + 25 + 2D; // Slot1-2 GT5000/6000
Input16 := 02 + 03 + 00 + 00 + 02 + 01 + 29 + 31; // Slot2-1 GT5000/6000
Input17 := 02 + 03 + 00 + 00 + 02 + 01 + 2A + 32; // Slot2-2 GT5000/6000

Input18 := 02 + 03 + 00 + 00 + 02 + 01 + 1B + 23; // DisplayPort / HDMI 2 (some only)

Input19 := 02 + 03 + 00 + 00 + 02 + 01 + A2 + AA; // HDMI2 in 2014 M/PA group V079
Input20 := 02 + 03 + 00 + 00 + 02 + 01 + A6 + AE; // DisplayPort in 2014 M/PA group V079

Input21 := 02 + 03 + 00 + 00 + 02 + 01 + 1F + 27; // USB-A/Viewer
Input22 := 02 + 03 + 00 + 00 + 02 + 01 + 22 + 2A; // USB-B/Display

Input23 := 02 + 03 + 00 + 00 + 02 + 01 + BF + C7; // HDBaseT

Input24 := 02 + 03 + 00 + 00 + 02 + 01 + A6 + AE; // ALTERNATE DisplayPort

```

Any one of these codes can be set into Constant:0/Constant:1 for computer codes and Constant:2/Constant:3 for video codes. (The default is to have Computer1 (above) as the “Computer” channel and Video1 as the “Video” channel. Setting OPT1 switch ON will swap Video1 and Video2 channels, making S-Video the video default. Setting OPT5 will swap Computer1 and Computer2. Setting OPT4 will allow double- presses on some keyboards.).

- OPT7 handshake mode and power on panel connection blink codes available.
- Make sure to turn off “Eco” mode.

## Aspect ratio setting for NEC family

The aspect ratio codes for all NEC projectors are the same, but are interpreted differently with different models. Note that to use these, enable bits for ratios usable by each channel must be set into UserFlags[0..3] and the preselected or “default” aspect setting must be set into UserFlags[5..8] The functions provided are as follows:

```

SetAspect1 := 03 + 10 + 00 + 00 + 05 + 18 + 00 + 00 + 00 + 00 + 30; // Small video image 4:3 / normal / auto or 5:4
SetAspect2 := 03 + 10 + 00 + 00 + 05 + 18 + 00 + 00 + 01 + 00 + 31; // Letterbox /Regular video image 4:3 / wide
SetAspect3 := 03 + 10 + 00 + 00 + 05 + 18 + 00 + 00 + 02 + 00 + 32; // Wide screen or video image 16:9 or Cinema
SetAspect4 := 03 + 10 + 00 + 00 + 05 + 18 + 00 + 00 + 03 + 00 + 33; // Wide video Native
SetAspect5 := 03 + 10 + 00 + 00 + 05 + 18 + 00 + 00 + 04 + 00 + 34; // 4:3 fill or 2.35:1
SetAspect6 := 03 + 10 + 00 + 00 + 05 + 18 + 00 + 00 + 05 + 00 + 35; // Normal or auto or 15:9
SetAspect7 := 03 + 10 + 00 + 00 + 05 + 18 + 00 + 00 + 06 + 00 + 36; // Full or 16:10
SetAspect8 := 03 + 10 + 00 + 00 + 05 + 18 + 00 + 00 + 07 + 00 + 37; // Zoom or LetterBox

```

(Note that initial aspect ratio commands may not be accepted if there is no signal input to that channel.)

## RS232 connections to NEC projectors

Most use a male 8-pin mini-DIN. Others, see D9 below.

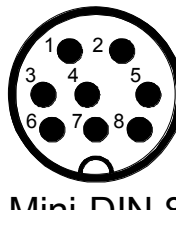
Function/Direction	T440 "projector" Connection	"Serial" Port Connector	
Ground	Ground	8-pin mini-DIN pin 4	
Data from T440 to projector	Tx	8-pin mini-DIN pin 1 RXD)	
Reply data from projector to T440	Rx	8-pin mini-DIN pin 7 TXD)	
Plus 9 volt CTS/DTR to projector	N/C	N/C	

After installation wiring of any projector to a T440, use a multimeter to check voltages of -9 on BOTH TX and RX pins in any installation, as described in the troubleshooting part of this manual.

## RS232 connections to NEC projectors

These use a 9-pin-D9 male on the projector, female on cable.

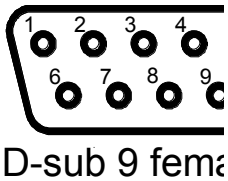
Function/Direction	T440 "projector" Connection	"Serial" Port Connector	
Ground	Ground	9-pin D-sub pin 5	
Data from T440 to projector	Tx	9-pin D-sub pin 2 (RXD)	
Reply data from projector to T440	Rx	9-pin D-sub pin 3 (TXD)	
Plus 9 volt CTS/DTR to projector	"RTS"	9-pin D-sub pin 8(CTS IN)	

## NEC projector via IR Code AE

NEC IR codes are provided for control of most NEC projectors.

Channel codes are:

```

Input1FunctionCode := $0004; // Computer 1
Input2FunctionCode := $0005; // Computer 2

Input3FunctionCode := $0003; // Video Composite * (OPT1 swaps Video1 & Video2)
Input4FunctionCode := $0054; // HDMI

* T440: OPT6 switch ON will use S-Video in place of HDMI/DVI. T430: Uses HDMI for Video2

Input4FunctionCode := $00C6; // S-Video * (OPT1 swaps Video1 & Video2)

Input5FunctionCode := $0031; // HDMI 2

Input6FunctionCode := $0032; // DisplayPort

Input7FunctionCode := $0056; // LAN

Input8FunctionCode := $0027; // USB-A / PC
Input9FunctionCode := $0052; // USB-B
    
```

- AV Mute and Freeze are supported;
- This projector has separate Power On and Power Off commands, and commands for each input so operation is very similar to RS232 controlled devices.



**Optoma Group 1:** DS309, EP721 / EP723 / EP727 / EP728, EW1610 (**Code 99** , Vol: 0->15)

**Optoma Group 2a:** (0/1 cmds, no DVI/HDMI) EH300, DH1011, HD25/LV, EH501, W501, X501, EH505, W505, EW605ST, EX605ST, EW610ST, EX610ST, TW610ST, TX610ST, EX850, EX850, EW860, EX865, EW635, EX635, TW635, TX635, EX400, W290, W316, ZU850 No audio: PRO8000, EH7500, TH7500, EH7700. (**Code 98** , Vol: 0->10).

**Optoma Group 2b:** (0/1/2 cmds, HDMI)

PRO150S, PRO250X, EX540, TX540, EX542, TX542, EX615, TX615, EX762, TX762, EX612, TX612, DX319, DS216, DS219, DS316, ES526, EX531, EX536, DS317, DS323, TS526, TX536, C222, ES520, EX520, ES530, EX530, DX617, ES522, EX532, DX623, EP776, EP782W, TX778W, EX779, TX779, EW775, TW775, EX785, TX785, TW6000, TX7000, EH500, X600, W305ST, X305ST, W306ST, X306ST, FW5200, FX5200, S303, W303, X303, S2010, X2010, S2015, W2015, X2015, W401, X401, ZW201ST, ZX\_201ST, ZW212ST, ZX212ST (**Code 90** , Vol: 0->10).

**Optoma Group 2c:** (1/2 cmds, DVI) EP752, EP761, EP763, EP783/TX783, EP1080/TX1080. (**Code 91** , Vol: 0->15).

**Optoma Group 2d:** (1/2 cmds HDMI, DVD) EP783, EP783/TX783, TX783 (**Code 93** , Vol: 0->16).

**Optoma Group 2e:** (0/1 cmds, HDMI) DS327, DX327, DS329, DS550, DX550, ES550, EX550, DS551, DX551, ES551, EX551, TS551, TX551, EX565UT, TX565UT, 565UT, EX665UST, TX665UST, EX665UT, EW675UT, TW675UT, EX685UT, EW695UTi, W307USTi, X307USTi, EW766W, TW766W, EX765W, TX765W (**Code 92** , Vol: 0->20).

**Optoma Group 2f:** (0/1 cmds, 1-100 vol, 9600) ZU720T

**Optoma Group 3a \*:** (1/2 cmds, DVI-A on 2) DS327/DX327, DS329/DX329, ES550, EX550, ES551, EX551, EW674, EX772, EX774, HD75, TXR774, TWR1693 (**Code 94** , Vol: 0->10) Note: If DVI-A is not used as Computer 2 use code 90 (2b above)

**Optoma Group 3b \*:** (1/2 cmds, DVI-A on 2) DX609, EP721, EP723, EP727, EP728, EX525ST, HD71 (**Code 95** , Vol: 0->15) Note: If DVI-A is not used as Computer 2 use code 91 (2c above)

**Optoma Group 4a \*\*:** DH1015, DS318, EW536, EW631, EH1020, EH1060, EH2060, EX542i, EW762/EX762, EX784, FW5200, GT360, GT700, GT720, HD66, HD600X, PRO350W, TH1020, TH1060, TW536 (**Code 96** , Vol: 0->10) Note: If HDMI is not used as Computer 2 use code 90 (2b above)

**Optoma Group 4b \*\*:** GT750, EHD87, HD33, HD3300, HD82LV, HD82, HD8200, HD83, HD8300, HD86, HD87, HD8600 (**Code 97** , no audio)

**Optoma Group 5:** See BenQ SP820 for EP771/EP772 projectors **Code 3B**

In the back of each "User's Manual" is a list of channel selection messages.

See master Optoma manual/code list at: <http://www.optoma.eu/support.aspx>

Group 1:

```
Input1 := '~0039 5' + 0D; //Computer1 VGA1 analog-RGB
Input2 := '~0039 6' + 0D; //Computer2 VGA2 analog-RGB
Input3 := '~0039 10' + 0D; //Video1 Comp Video* (OPT1 swaps Video1 & Video2)
Input4 := '~0039 2' + 0D; // DVI-D (not EW1610)* (OPT1 swaps Video1 & Video2)
*T440: OPT6 switch ON will use S-Video in place of DVI-D/HDMI T430: Uses DVI-D / HDMI as Video2
Input4 := '~0039 9' + 0D; //Video2 S-Video*
Input5 := '~0039 2' + 0D; // DVI-D (not EW1610)
```

Groups 2, 3, 4:

```

Input1 := '~0012 5' + 0D; //Computer1 VGA1 analog-RGB
Input2 := '~0012 6' + 0D; //Computer2 VGA2 analog-RGB
* Input2 := '~0012 3' + 0D; //Computer2 DVI-A Overwrite VGA2 with DVI-A (Groups 3a and 3b)
** Input2 := '~0012 1' + 0D; //Computer2 Overwrite VGA2 analog-RGB with HDMI 1 (Groups 4a, 4b)

Input3 := '~0012 10' + 0D; //Video1 Comp Video 1 * (OPT1 swaps Video1 & Video2)
Input4 := '~0012 1' + 0D; //Video2 HDMI 1

```

\* T440: OPT6 switch ON will use S-Video in place of DVI-D/HDMI T430: Uses DVI-D / HDMI as Video2

```

Input4 := '~0012 9' + 0D; //Video2 S-Video
Input5 := '~0012 8' + 0D; // VGA1 Component
Input6 := '~0012 13' + 0D; // VGA2 Component (some only)
Input7 := '~0012 14' + 0D; // Component RCA
Input8 := '~0012 4' + 0D; // BNC
Input9 := '~0012 3' + 0D; // DVI-A **NOT EP776,EP782 use Optoma8_4; to overwrite
Input10 := '~0012 2' + 0D; // DVI-D **NOT EP776,EP782 use Optoma8_3; to overwrite
Input11 := '~0012 1' + 0D; // HDMI 1
Input12 := '~0012 15' + 0D; // HDMI 2 EH1060, EH2060, HD82
Input13 := '~0012 16' + 0D; // HDMI 3 HD82, HD86, HD8600
Input14 := '~0012 11' + 0D; // Wireless **EP776,EP782 only
Input15 := '~0012 21' + 0D; // HDBaseT V141
Input16 := '~0012 18' + 0D; // Network Display
Input17 := '~0012 22' + 0D; // 3GSDI

```

#### Code 9A (Group 2f) allows selection between 2 HDMI ports as default. Volume is 0-100

```

Input1 := '~0012 5' + 0D; //Computer1 VGA1 analog-RGB
Input2 := '~0012 1' + 0D; //Computer2 HDMI 1
Input3 := '~0012 15' + 0D; //Video1 HDMI 2
Input4 := '~0012 21' + 0D; //Video2 HDBaseT

```

Any one of these codes can be set into Constant:0/Constant:1 for computer codes and Constant:2/Constant:3 for video codes. (The default is to have Computer1 (above) as the “Computer” channel and Video1 as the “Video” channel. Setting OPT1 switch ON will swap Video1 and Video2 channels, making S-Video the video default. Setting OPT5 will swap Computer1 and Computer2. Setting OPT4 will allow double-presses on some keyboards.).

- **All these need a projector address set to 00 so power-up works (change from previous);**
- This panel can be used with a number of keyboards;
- With a “Code 9” or “Code B” keyboard, with buttons selecting “Video” and ‘Computer’, with “Volume Up/Dn”;
- Freeze command is available (on some only), so “Code 8 or A” keyboards are OK;
- Two-yellow button “Mute” command is supported;
- OPT7 handshake mode and power on panel connection blink codes available.
- The “Source Lock” option in the “Options” menu MUST be turned ON (to stop the projector searching for other channels when an input is dropped.);
- The “Direct Power On” in “Options -> Advanced” MUST be set to OFF; and
- The “Eco Standby Power” in “Options -> Advanced” MUST be set to OFF.

#### Aspect ratio setting for above Optoma family

The aspect ratio codes for all Optoma projectors are the similar ... some have only 4:3 and basic 16:9, some have 9 ratios. The codes are shown below for the first 8, and the 9<sup>th</sup> is covered below

Note that to use these, enable bits for ratios usable by each channel must be set into UserFlags[0..3] and the preselected or “default” aspect setting must be set into UserFlags[5..8]

```

SetAspect1 := '~0060 1'+ 0D; // Regular video image 4:3
SetAspect2 := '~0060 2'+ 0D; // Wide video image 16:9-I or 16:10
SetAspect3 := '~0060 3'+ 0D; // Wide video image 16:9-II (some only)
SetAspect4 := '~0060 4'+ 0D; // Window (some only)
SetAspect5 := '~0060 5'+ 0D; // LBX (some only)
SetAspect6 := '~0060 6'+ 0D; // Native (some only)
SetAspect7 := '~0060 7'+ 0D; // Auto (some only)
SetAspect8 := '~0060 8'+ 0D; // Auto235 (some only)

```

“Superwide” is not covered: Used only on HD82/HD82LV/HD86 Command: '~0060 9'+ 0D;  
Use a fixed 2.0:1 screen and manually setup "Superwide"

## RS232 connections to 3-Pin DIN Optoma Groups 1 ... 4 (see D-Sub next “Optoma” page)

Mini-DIN 3 socket on projector. Coms at: 9600 DP8N1

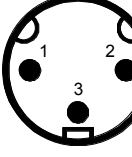
Function/Direction	T440 “projector” Connection	Optoma 3-pin Serial Port Connector	
Ground	Ground	Mini-DIN 3 pin 3 (Gnd)	
Data from T440 to projector	Tx	Mini-DIN 3 pin 2 (RXD)	
Reply data from projector to T440	Rx	Mini-DIN 3 pin 1 (TXD)	

After installation wiring of any projector to a T440, use a multimeter to check voltages of –9 on BOTH TX and RX pins in any installation, as described in the troubleshooting part of this manual.

## Optoma Group 6: HD803/ HD803LV (Code 0F )

In the back of the “User’s Manual” is a list of channel selection messages. Unfortunately they omit the Component channel. The code \* 0 IR 050 <CR> for HDMI-2 does work, where code \* 0 IR 022<CR> in newer data does not.

```

Input1 := '* 0 IR 020'+ 0D; //Computer1 DVI analog via DVI -RGB VGA
Input2 := '* 0 IR 021'+ 0D; //Computer2 Component

Input3 := '* 0 IR 018'+ 0D; //Video1 Comp Video ) * (OPT1 swaps Video1 & Video2)
Input4 := '* 0 IR 017'+ 0D; // HDMI 1 * (OPT1 swaps Video1 & Video2)

```

\* T440: OPT6 switch ON will use S-Video in place of DVI-D/HDMI T430: Uses DVI-D / HDMI as Video2

```

Input4 := '* 0 IR 019'+ 0D; //Video2 S-Video *
Input5 := '* 0 IR 021'+ 0D; // Component

Input6 := '* 0 IR 016'+ 0D; // DVI digital via DVI (also runs DVI-A !??)
Input7 := '* 0 IR 017'+ 0D; // HDMI 1
Input8 := '* 0 IR 050'+ 0D; // HDMI 2

```

Any one of these codes can be set into Constant:0/Constant:1 for computer codes and Constant:2/Constant:3 for video codes. (The default is to have Computer1 (above) as the “Computer” channel and Video1 as the “Video” channel. Setting OPT1 switch ON will swap Video1 and Video2 channels, making S-Video the video default. Setting OPT5 will swap Computer1 and Computer2. Setting OPT4 will allow double- presses on some keyboards.).

This projector has **no audio and no mute or freeze commands**, so it is best used with only keyboards 0 or 5.

If OPT4 is enabled with a code 0 keyboard, two computer and two video channels can be allocated. Component, HDMI-1 and HDMI-2 can be used in either Computer or Video groups.

- OPT7 handshake mode and power on panel connection blink codes available.
- The “Source Lock” option in the “Setup” menu MUST be turned ON (to stop the projector searching for other channels when an input is dropped.)

## RS232 connections to Optoma Group 2: EP776, EP782 projector with D9

These use a 9-pin-D9 male on the proj, female on cable. Comms is at 9600 baud, 8 bits, no parity, 1 stop.

## RS232 connections to D-9 Optoma Group 6: HD803/LV

These use a 9-pin-D9 male on the proj, female on cable. Comms at 115200, 8N1

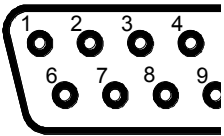
Function/Direction	T440 "projector" Connection	"Serial" Port Connector	 D-sub 9 female
Ground	Ground	9-pin D-sub pin 5	
Data from T440 to projector	Tx	9-pin D-sub pin 2 (RXD)	
Reply data from projector to T440	Rx	9-pin D-sub pin 3 (TXD)	
Plus 9 volt CTS/DTR to projector	n/c	n/c	

After installation wiring of any projector to a T440, use a multimeter to check voltages of -9 on BOTH TX and RX pins in any installation, as described in the troubleshooting part of this manual.

## Optoma Group 7: EP706, EP708S, EP709, EP712E, EP719H (Code 0B )

Channel allocations are as follows:

```

Input1 := 'ID00IR021'; //Computer1 DSUB1 VGA RGB/YPbPr/YCbCr/SCART
Input2 := 'ID00IR022'; //Computer2 DSUB2 RGB (EP719H Only)

Input3 := 'ID00IR024'; //Video1 Comp Video
Input4 := 'ID00IR023'; //Video2 S-Video
Input5 := 'ID00IR021'; //Video3 Component on DSUB1 VGA
  
```

Any one of these codes can be set into Constant:0/Constant:1 for computer codes and Constant:2/Constant:3 for video codes. (The default is to have Computer1 (above) as the "Computer" channel and Video1 as the "Video" channel. Setting OPT1 switch ON will swap Video1 and Video2 channels.)

- This projector has **no audio** so use a T441/T461 if audio control needed.
- Absolute freeze and mute commands are available so a code A keyboard works OK
- If OPT4 is enabled with a code 0, 0 or A keyboard, two computer and two video channels can be allocated.
- NO power on panel connection blink codes or OPT7 handshake modes are available.
- The "Source Lock" option in the "Management-I" menu MUST be turned ON (to stop the projector searching for other channels when an input is dropped.)

## RS232 connections to 3-Pin DIN Optoma projectors.

Mini-DIN 3 socket on projector. Coms at: 9600 DP8N1

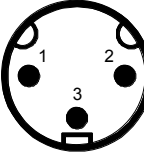
Function/Direction	T460 "projector" Connection	Optoma/Acer Serial Port Connector	 Mini-DIN 3
Ground	Ground	Mini-DIN 3 pin 3 (Gnd)	
Data from T460 to projector	Tx	Mini-DIN 3 pin 1 or 2 (RXD)	
Reply data from projector to T460	Rx	Mini-DIN 3 pin 2 or 1 (TXD)	

## Panasonic projectors (Codes 30 to 39)

(for PT-CW230 / CX200 Series see Sanyo code 80)

Good set of current model RS232 codes: <https://www.pavc.panasonic.co.jp/projector/extranet/main/sitemap/index.html>

### Code 30 : (Group 1): OSH mute/IIS:HD1 unmute, abs audio, 9600 comms:

PT-L501/701, L502/702, L511/711/712, PT-L735, PT-F200, PT-LB50/51/55/60, PT-LB280, PT-LB300, PT-LB330, PT-LB360, PT-LC55/56/75/76/80, PT-LW280, PT-LW330, PT-LX26HE, PT-LX30HE, PT-P1SDE, PT-LW25HE, PT-LX22E, PT-LX26E, PT-VX400E/VGA, PT-VX500E, and a lot more;

**Code 33 : (Group 1a): OSH mute/OSH unmute, abs audio, 9600 comms:** PT-AX200, PT-LB75, PT-LB78, PT-F200/F200NT, PT-F300, PT-FW300, PT-LP51.

### Code 31 : (Group 2): OSH:1 mute/OSH:0 unmute, abs audio, 9600 comms:

PT-LB75NT, PT-LB80/NT, PT-F100/F100NT/FW100NT, PT-FX400/FW430, PT-LB1E/V, PT-LB2E/V, PT-LB3, PT-LB60U/NTU, PT-LB75/LB75NT, PT-LB78, PT-LB80/LB80NT, PT-LB90NTE, PT-LW25HU/HE/HEA, PT-LW80NT, PT-LX22U/E/EA, PT-LX26U/E/EA, PT-LX26HU/HE/HEA, PT-LX30HU/HE/HEA, PT-LZ370U/E/EA, PT-ST10E/U, PT-TW230U/E/EA, PT-TW231RU/R/REA, PT-TW240E, PT-TW330E, PT-TX300E, PT-XW23ST, PT-XW25SR, PT-X260, PT-UW250, PT-UX220, PT-UX260, PT-UX300, PT-VW330, PT-VW430E, PT-VW431DE, PT-VW440E, PT-VW435NU/NE/NEA, PT-VW530, PT-VW535N, PT-VX400/NT, PT-VW430, PT-VW431D, PT-VW435NE, PT-VX41, PT-VX45, PT-VX60, PT-VX405, PT-VX500, PT-VX510E, PT-VX505NU/NE/NEA, PT-VX600, PT-VX605N, PT-VZ570, PT-VZ575N, PT-X260, PT-X300.

**Code 32 : (Group 3): OSH mute/ IIS:HD1 unmute, NO audio, 9600 comms:** PT-AE900/AX100/AX200, PT-AE2000, PT-AE4000E, PT-AE7000U, PT-AE8000EH, PT-AT5000E, PT-AE6000E

**Code 35 : (Group 4): As Group 2 but different Inputs 1&2, 9600 comms:** PT-LX22, PT-LX26

**Code 38 : (Group 5): OSH:1 mute/OSH:0 unmute, Inc audio, 19200 comms:** PT-CW330, PT-CX300, PT-CW240, PT-CW331RE, PT-CX301, PT-CW241RE, PT-LW271, PT-LW321, PT-LX270, PT-LX271, PT-LX300, PT-LX321, PT-LX351, PT-TW330, PT-TX300, PT-TW240, PT-TW331RE, PT-TX301RE, PT-TW241RE

**Code 39 : (Group 6): OSH mute/IIS:HD1 unmute, Inc audio, 19200 comms:** PT-LW330, PT-LW280, PT-LB360, PT-LB330, PT-LB300, PT-LB280

Note: Panasonic have used toggle mode in the past for the “shutter” or mute function, which makes it hard to know the current mute state for the two-yellow-button-mute-mode, and the MUTE key in the freeze/mute keyboard (code A). We have determined that the use of the OSH command to turn ON the mute mode and the use of the PON (Power On) to exit mute mode works OK on these (Groups 1 and 3 above). (Group 1a, Code 33 are ones which do not allow PON as a cancel for OSH, so we just use toggle mode. Note: If \$30 does not work on any, use \$33) Panasonic have recently made it easier by introducing absolute shutter control by adding OSH:1 (Shutter ON) and OSH:0 (Shutter OFF) commands which give proper control. These recent ones are the Group 2 in this family.

Channel codes for 30, 31, 32 & 35 are:

```
Input1 := 02 + 'IIS:RG1' + 03; //Computer1 RGB 1 VGA analog-RGB (Code 30, 31, 32)
or Input1 := 02 + 'IIS:RG' + 03; //Computer1 RGB special VGA analog-RGB (Code 35)
Input2 := 02 + 'IIS:RG2' + 03; //Computer2 RGB 2 VGA analog-RGB (Code 30, 31, 32)
or Input2 := 02 + 'IIS:HD1' + 03; // HDMI (as no RGB2) (Code 35)
Input3 := 02 + 'IIS:VID' + 03; //Video1 Vid composite *(OPT1 swaps Video1 & Video2)
Input4 := 02 + 'IIS:HD1' + 03; //Video 2 HDMI 1 *(OPT1 swaps Video1 & Video2)
* T440: OPT6 switch ON will use S-Video in place of HDMI T430: Uses HDMI as Video2
Input4 := 02 + 'IIS:SVD' + 03; //Video2 S-Video *
Input5 := 02 + 'IIS:YUV' + 03 // Component
Input6 := 02 + 'IIS:CP1' + 03; // Component 1
Input7 := 02 + 'IIS:CP2' + 03; // Component 2
Input8 := 02 + 'IIS:HDM' + 03; // HDMI
Input9 := 02 + 'IIS:HD1' + 03; // HDMI 1
Input10 := 02 + 'IIS:HD2' + 03; // HDMI 2
Input11 := 02 + 'IIS:HD3' + 03; // HDMI 3
```

```

Input12 := 02 + 'IIS:AUX' + 03; // Aux
Input13 := 02 + 'IIS:NWP' + 03; // Network
Input14 := 02 + 'IIS:DVI' + 03; // DVI-I
Input15 := 02 + 'IIS:DL1' + 03; // DigitalLink
Input16 := 02 + 'IIS:DL1:VID' + 03; // DigitalLink:Video
Input17 := 02 + 'IIS:DL1:SVD' + 03; // DigitalLink:S-Video
Input18 := 02 + 'IIS:DL1:RG1' + 03; // DigitalLink:RGB 1
Input19 := 02 + 'IIS:DL1:RG2' + 03; // DigitalLink:RGB 2
Input20 := 02 + 'IIS:DL1:HD1' + 03; // DigitalLink:HDMI 1
Input21 := 02 + 'IIS:DL1:HD2' + 03; // DigitalLink:HDMI 2
Input22 := 02 + 'IIS:DL1:PC1' + 03; // DigitalLink:PC 1
Input23 := 02 + 'IIS:DL1:PC2' + 03; // DigitalLink:PC 2

```

**Code 34 : (Group 7): Address mode, OSH:1 mute/OSH:0 un-mute, abs or no audio,**

PT-D3500, PT-D4000, PT-D5000E, PT-D5500, PT-D5600, PT-D5700, PT-D6000E, PT-D7700, PT-D10000, PT-D12000, PT-DS12KE, PT-DS20K, PT-DS100XE, PT-DS8500U,

PT-DW11KE, PT-DW17K, PT-DW90XE, PT-DW100E, PT-DW530E, PT-DW640L/K/S, PT-DW730E/L/U/S, PT-DW740L/K/S, PT-DW830E, PT-DW5000, PT-DW5100, PT-DW6300E, PT-DW7000, PT-DW8300/U, PT-DW10000, PT-DX100E, PT-DX500E, PT-DX610L/K/S, PT-DX800E/L/U/S, PT-DX810L/K/S,

PT-DZ16KU/KE/KD, PT-DZ21K, DZ110XE, PT-DZ110XE, PT-DZ570E, PT-DZ680L/K/S, PT-DZ770L/K/S, PT-DZ870E, PT-DZ6700E, PT-DZ6710E, PT-DZ10KE, PT-DZ13KE, PT-DZ8700U, PT-DZ12000, PT-L785,

PT-EW530E, PT-EW540, PT-EW630E, PT-EW640/L, PT-EW730Z,

PT-EX12KE/U, PT-EX16K, PT-EX500E, PT-EX510, PT-EX600E, PT-EX610, PT-EX800Z,

PT-EZ570E, PT-EZ580, PT-EZ770Z, PT-RW330, PT-RW430, PT-RW630, PT-RZ370, PT-RZ470, PT-RZ475, PT-RZ670

PT-SLX12KC, PT-VW340Z, PT-VW345NZ, PT-VW435N,

PT-VX415NZ, PT-VX42Z, PT-VX410Z, PT-VX505N

**Code 36 : (Group 8): Address mode, OSH:1 mute / ADZZ;IIS:HD1un-mute, abs or no audio,**

PT-LZ370U (Code 31 may work with this too.)

Channel codes for 34 and 36 are:

```

Input1 := 02 + 'ADZZ;IIS:RG2' + 03; //Computer1 RGB 2 DB15-VGA analog-RGB
Input2 := 02 + 'ADZZ;IIS:RG1' + 03; //Computer2 RGB 1 BNC (or DB15-VGA PT-L785)

Input3 := 02 + 'ADZZ;IIS:VID' + 03; //Video1 Vid composite *(OPT1 swaps Video1 & Video2)
Input4 := 02 + 'ADZZ;IIS:HD1' + 03; //Video 2 HDMI 1 *(OPT1 swaps Video1 & Video2)

* T440: OPT6 switch ON will use S-Video in place of DVI-D/HDMI T430: Uses DVI-D / HDMI as Video2
Input4 := 02 + 'ADZZ;IIS:SVD' + 03; //Video2 S-Video *
Input5 := 02 + 'ADZZ;IIS:DVI' + 03; // DVI-D

Input6 := 02 + 'ADZZ;IIS:AUX' + 03; // Auxiliary
Input7 := 02 + 'ADZZ;IIS:RG3' + 03; // RGB 3 BNC on some
Input8 := 02 + 'ADZZ;IIS:CP1' + 03; // Component
Input9 := 02 + 'ADZZ;IIS:CP2' + 03; // Component 2

Input10 := 02 + 'ADZZ;IIS:HD1' + 03; // HDMI 1
Input11 := 02 + 'ADZZ;IIS:HD2' + 03; // HDMI 2
Input12 := 02 + 'ADZZ;IIS:HD3' + 03; // HDMI 3

Input13 := 02 + 'ADZZ;IIS:NWP' + 03; // Network

Input14 := 02 + 'ADZZ;IIS:SDI' + 03; // SDI (Single BNC)
Input15 := 02 + 'ADZZ;IIS:SD1' + 03; // SDI-1 (Single BNC)
Input16 := 02 + 'ADZZ;IIS:SD2' + 03; // SDI-2 (Single BNC) V065

Input17 := 02 + 'ADZZ;IIS:DL1' + 03; // DigitalLink V079

```

```

Input18 := 02 + 'ADZZ;IIS:DL1:VID' + 03; // DigitalLink:Video
Input19 := 02 + 'ADZZ;IIS:DL1:SVD' + 03; // DigitalLink:S-Video
Input20 := 02 + 'ADZZ;IIS:DL1:RG1' + 03; // DigitalLink:RGB 1
Input21 := 02 + 'ADZZ;IIS:DL1:RG2' + 03; // DigitalLink:RGB 2
Input22 := 02 + 'ADZZ;IIS:DL1:HD1' + 03; // DigitalLink:HDMI 1
Input23 := 02 + 'ADZZ;IIS:DL1:HD2' + 03; // DigitalLink:HDMI 2
Input24 := 02 + 'ADZZ;IIS:DL1:PC1' + 03; // DigitalLink:PC 1
Input25 := 02 + 'ADZZ;IIS:DL1:PC2' + 03; // DigitalLink:PC 2

```

Any one of these codes can be set into Constant:0/Constant:1 for computer codes and Constant:2/Constant:3 for video codes. (The default is to have Computer1 (above) as the “Computer” channel and Video1 as the “Video” channel. Setting OPT1 switch ON will swap Video1 and Video2 channels, making HDMI the video default. Setting OPT5 will swap Computer1 and Computer2. Setting OPT4 will allow double-presses on some keyboards.).

Power on panel connection blink codes are provided, but OPT7 handshake mode is NOT;

- Auto Pixel Align is NOW available;
- Picture and sound mute is available with two-yellow-button mute mode with a “volume” keyboard;
- Mute and freeze keyboard code 8 or A are available;
- Make sure to turn off “Auto input search” if your projector includes this;
- Make sure to set the baud rate to 9600 and no parity if an adjustment menu is provided. Select “AMX D. D.” mode if only 19200 mode is shown ... this will set 9600 baud. **If no AMX mode, use codes 38 and 39 above.**

### RS232 connections to Panasonic projectors: Three systems in use:

#### D-SUB 9 Female on projector, male on cable. Comms at 9600 8N1

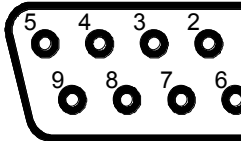
Function/Direction	T440 “projector” Connection	Panasonic Serial Port Connector	
Ground	Ground	9-pin D-sub pin 5	 <p>D-sub 9 male</p>
Data from T440 to projector	Tx	9-pin D-sub pin 3 (RXD)	
Reply data from projector to T440	Rx	9-pin D-sub pin 2 (TXD)	
Plus 9 volt CTS/DTR to projector	N/C	N/C	

#### D-SUB 9 Male on projector, female on cable. Comms at 9600 8N1

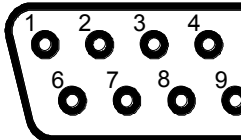
Function/Direction	T440 “projector” Connection	Panasonic Serial Port Connector	
Ground	Ground	9-pin D-sub pin 5	 <p>D-sub 9 female</p>
Data from T440 to projector	Tx	9-pin D-sub pin 2 (RXD)	
Reply data from projector to T440	Rx	9-pin D-sub pin 3 (TXD)	
Plus 9 volt CTS/DTR to projector	N/C	N/C	

#### Mini-DIN-8 socket on projector. Comms at 9600 8N1

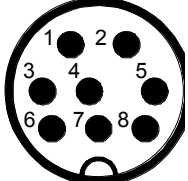
Function/Direction	T440 “projector” Connection	Panasonic Serial Port Connector	
Ground	Ground	mini-DIN 8 pin 4	 <p>Mini-DIN 8</p>
Data from T440 to projector	Tx	mini-DIN 8 pin 3 (RXD)	
Reply data from projector to T440	Rx	mini-DIN 8 pin 5 (TXD)	
Plus 9 volt CTS/DTR to projector	N/C	N/C	

After installation wiring of any projector to a T440, use a multimeter to check voltages of –9 on BOTH TX and RX pins in any installation, as described in the troubleshooting part of this manual.

## Plus projector families: U5, U7 (Codes 64 ... 67 )

Channel codes are:

```

Input1 := '#SR' + 0D + 0A; //Computer1 RGB 1 VGA analog-RGB
Input2 := '#SA' + 0D + 0A; //Computer2 RGB 2 VGA analog-RGB2 on U7, DVI on some

Input3 := '#SV' + 0D + 0A; //Video1 Comp Video
Input4 := '#SS' + 0D + 0A; //Video2 S-Video

Input5 := '#SN' + 0D + 0A; // Network (U7 only)

```

Any one of these codes can be set into Constant:0/Constant:1 for computer codes and Constant:2/Constant:3 for video codes. (The default is to have Computer1 (above) as the “Computer” channel and Video1 as the “Video” channel. Setting OPT1 switch ON will swap Video1 and Video2 channels, making S-Video the video default. Setting OPT5 will swap Computer1 and Computer2. Setting OPT4 will allow double- presses on some keyboards.).

- OPT7 handshake mode and power on connection blink codes available;
- Turn off the auto-source feature;
- Freeze and blank (toggle) are supported (keyboard code A), and any non-volume keyboard; and
- Absolute mute is not supported, so even if using a T441/461, absolute video mute is not available.

## RS232 connections to Plus U5, U7 projectors

These use a 9-pin-D9 male on the projector, female on cable. Comms is at 19200 baud, 8 bits, no parity, 1 stop.

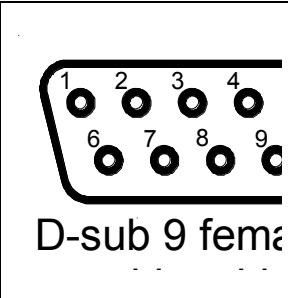
Function/Direction	T440 “projector” Connection	“Serial” Port Connector	
Ground	Ground	9-pin D-sub pin 5	
Data from T440 to projector	Tx	9-pin D-sub pin 3	
Reply data from projector to T440	Rx	9-pin D-sub pin 2	
Plus 9 volt CTS/DTR to projector	N/C	N/C	

After installation wiring of any projector to a T440, use a multimeter to check voltages of –9 on BOTH TX and RX pins in any installation, as described in the troubleshooting part of this manual.

## Baud rate change

This family of projectors can be operated at 115,200 baud or 19,200 baud. As shipped from Plus, communications is at 115,200 baud, and **must be set to 19,200 for use with a T440/T430 to get reasonable wiring length.**

**A built-in baud rate changer is incorporated as dummy channels in the T430/T440, using codes 65 and 66 .** In operation, selecting code 67 will control the projector at 115200 (not recommended for install). Use 64 for install to run at 19200 baud.

Switch to 19,200 as follows:

Wire to the projector via a short cable (in the workshop). Set code 67 and verify the projector operates OK at 115200 baud (One red blink then steady, On, Off, channels working OK)

Set a projector code of address of 65 , and reset the T440 with the reset switch.

The red OFF LED will come on steady.

Press the/an ON button. The #CL<CR><LF> baud rate change command is sent to the projector.

Set a projector code of 64 , and reset the T440 with the reset switch. Check the operation at 19200: (One red blink then steady, On, Off, channels working OK) **It is ready for use.**

(If the projector needs to be reset to operate at 115200, set code 66 and reset the T430/440. The red OFF LED will come on steady. Press the/an ON button. The #CH<CR><LF> baud rate change command is sent to the projector.

Set code 67 and Reset the T440, and verify the projector operates OK at 115200 baud (One red blink then steady, On, Off, channels working OK) The baud rate is held in projector non-volatile memory, so the baud rate setting to 19,200 need be done only once.



## ProjectionDesign & Christie: (Code 9C and 9D )

ProjectionDesign projectors support two completely different protocols:

1. A short ASCII sequence starting with a “:”, such as “:POWR1<CR>” for “Power On” and “:IVGA<CR>” for VGA source. This is known as the “**10bit electronics platform (392)**” and projectors type: **F12, FR12, F22, F32, FL32, F80, and F82** are supported by that protocol exclusively.) These are sent with code 9D .
2. A “binary” protocol: These commands are 32-byte strings starting with “BE EF”, with CRC codes at bytes 6 and 7 and an “operation byte” at byte 17. These projectors are: **F1/F2, evo, action, eCinema, F3, F3+**, several “generic” units and **Christie 20DS/25/26/30**. These are sent with code 9C .

**Note: Some projectors seem to support BOTH protocols. Try the ASCII one first.**

Support web site for newer projectors is: <http://www.projectiondesign.com/?CatID=1070>

To access older projectors (including ones listed in the “Binary” group below, select one of the newer ones, and then click on “discontinued” at the left-hand link list: <http://www.projectiondesign.com/Default.asp?CatID=1173>

### F12, FR12, F22, F32, FL32, F80, and F82 ASCII protocol, Code 9C

Channel codes are:

```
Input1 := ':IVGA' + 0D; //Computer1 VGA
Input2 := ':IDVI' + 0D; //Computer2 DVI-I

Input3 := ':ICVI' + 0D; //Video1 Composite Video *(OPT1 swaps Video1 & Video2)
Input4 := ':IHDM' + 0D; //Video2 HDMI *(OPT1 swaps Video1 & Video2)
```

\* T440: OPT6 switch ON will use S-Video in place of DVI-D/HDMI T430: Uses DVI-D / HDMI as Video2

```
Input4 := ':ISVI' + 0D; // S-Video *
Input5 := ':IYPP' + 0D; // Component
Input6 := ':IDVI' + 0D; // RGB Video
Input7 := ':IHDM' + 0D; // HDMI
Input8 := ':IBNC' + 0D; // BNC
```

Any one of these codes can be set into Constant:0/Constant:1 for computer codes and Constant:2/Constant:3 for video codes. (The default is to have Computer1 (above) as the “Computer” channel and Video1 as the “Video” channel. Setting OPT1 switch ON will swap Video1 and Video2 channels, making S-Video the video default. Setting OPT5 will swap Computer1 and Computer2.

- No audio commands are provided ... the above projectors don't have audio. Use a T441 or T461 instead
- OPT7 handshake mode is available;
- Power on connection blink codes available;
- Turn off the auto-source feature;
- Freeze and video blank are supported (keyboard codes 7 and A), and any non-volume keyboard;
- Set baud rate to 19200;
- Note: Picture Blank does not work reliably, so has not been included. (It causes a latch-up only clearable with a power disconnection.)

F1/F2, evo, action, eCinema, F3, F3+, several “generic” units, Christie 20DS/25/26/30, Code 9D

All “binary” commands to these projectors are 32-byte strings starting with “BE EF”, with CRC codes at bytes 6 and 7 and an “operation byte” at byte 17. The listings below just show the 17<sup>th</sup> byte.

Channel codes are:

Byte 17	F1/F2,evo,Christie 20DS/25	F3/F3+	Generic
Input1 := 00 //Computer1	VGA1	BNC	VGA1
Input2 := 01 //Computer2	VGA2	VGA	VGA2
Input3 := 05 //Video1	Comp. Vid.	Comp. Vid.	Comp. Vid
Input4 := 02 //Video2	DVI	DVI	DVI
(OPT1 swaps Video1 & Video2)			
* T440: OPT6 switch ON will use S-Video in place of DVI-D/HDMI T430: Uses DVI-D / HDMI as Video2			
* Input4 := 04 //Video2	S-Video	S-Video	S-Video
Input5 := 03 //	N/C	N/C	Component
Input6 := 02 //	DVI	DVI	DVI
Input7 := 06 //	Component	Component	HD

Any one of these codes can be set into Constant:0/Constant:1 for computer codes and Constant:2/Constant:3 for video codes. (The default is to have Computer1 (above) as the “Computer” channel and Video1 as the “Video” channel. Setting OPT1 switch ON will swap Video1 and Video2 channels, making S-Video the video default. Setting OPT5 will swap Computer1 and Computer2. **This might be a good idea for the F3/F3+ as it uses the “VGA1” code for a collection of RGBHV on 5 x BNC connectors.** Setting OPT4 will allow double- presses on some keyboards.)

- For projectors which have audio provided, volume Inc and Volume Dec are supported with keyboards with volume control keys;
- Two yellow-key MUTE is supported on “volume control” keyboards;
- OPT7 handshake mode is NOT available;
- Power on connection blink codes is available;
- Turn off the auto-source feature;
- Freeze and blank are supported (keyboard codes 7 and A), and any non-volume keyboard;
- Note: Picture Blank does not work reliably, so has not been included. (It causes a latch-up only clearable with a power disconnection.)
- Set baud rate to 19200.

## RS232 connections to ProjectionDesign & Christie

These use a 9-pin-D9 female on the projector, male on cable. Comms is at 19200 baud, 8 bits, no parity, 1 stop.

Function/Direction	T440 “projector” Connection	“Serial” Port Connector
Ground	Ground	9-pin D-sub pin 5
Data from T440 to projector	Tx	9-pin D-sub pin 3
Reply data from projector to T440	Rx	9-pin D-sub pin 2
Plus 9 volt CTS/DTR to projector	N/C	N/C

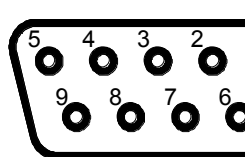

D-sub 9 ma

After installation wiring of any projector to a T440, use a multimeter to check voltages of –9 on BOTH TX and RX pins in any installation, as described in the troubleshooting part of this manual.

## Promethean:

**PRM-10, PRM-20:** see Sanyo/Eiki Code 86

**PRM-25, PRM-35, ESTP1:** See Vivitek

**PRM-30:** see Sanyo/Eiki Code 06

**Ricoh: (Code 17)** PJX3131, PJX3231, PJX3241, RGB1/2, Regulus STX/ETX group, Inc/Dec Vol, 9600  
**Ricoh: (Code 18)** PJX3340, PJX4240, PJWX4240, RGB1/2, Altair, #/CR group, Vol 0->50, only at 115k  
**Ricoh: (Code 19)** PJWX4141, RGB1, Soleil, #/CR group, Vol 0->50, only at 115k  
**Ricoh: (Code 1A)** PJWX5350N, PJX5360N, RGB1/2, #/CR group, Vol 0->50, at 9600 baud  
**Ricoh: (Code 1B)** PJWX5361N, PJX5371N, RGB1, HDMI1/2, #/CR group, Vol 0->31, at 9600 baud

Ricoh is supported by two code groups, with differences in audio, channel commands and baud rates between families. Support web site for projectors (limited protocol at back) is: <http://www.ricoh.com.au/download-documents>

**Code 17 Channel codes are:**

```
Input1 := 02 + 'IN1' + 03; //Computer1 VGA 1
Input2 := 02 + 'IN3' + 03; //Computer2 VGA 2 Code 19 uses HDMI 1 for Input 2

Input3 := 02 + 'IN9' + 03; //Video1 Composite Video *(OPT1 swaps Video1 & Video2)
Input4 := 02 + 'INA' + 03; //Video2 S-Video *(OPT1 swaps Video1 & Video2)

* T440: OPT6 switch ON will use S-Video in place of HDMI T430: Uses HDMI as Video2
Input4 := 02 + 'IN5' + 03; //Video2 HDMI

Input5 := 02 + 'IN2' + 03; // Component 1
Input6 := 02 + 'IN4' + 03; // Component 2
Input7 := 02 + 'INC' + 03; // Network
Input8 := 02 + 'IND' + 03; // USB Viewer
```

**Code 18, 19, 1A, 1B Channel codes are:**

```
Input1 := '#INP:1' + 0D; // Computer1 VGA 1
Input2 := '#INP:3' + 0D; // Computer2 VGA 2 Code 1B uses HDMI 2 for Input 2
Input3 := '#INP:9' + 0D; // Video1 Composite Video *(OPT1 swaps Video1 & Video2)
Input4 := '#INP:5' + 0D; // HDMI *(OPT1 swaps Video1 & Video2)

* T440: OPT6 switch ON will use S-Video in place of HDMI T430: Uses HDMI as Video2
Input4 := '#INP:10' + 0D; // S-Video

Input5 := '#INP:2' + 0D; // Component
Input6 := '#INP:12' + 0D; // Network
Input7 := '#INP:13' + 0D; // Viewer / USB
Input8 := '#INP:14' + 0D; // USB
Input9 := '#INP:6' + 0D; // HDMI 2
```

Any one of these codes can be set into Constant:0/Constant:1 for computer codes and Constant:2/Constant:3 for video codes. (The default is to have Computer1 (above) as the “Computer” channel and Video1 as the “Video” channel. Setting OPT1 switch ON will swap Video1 and Video2 channels, making HDMI the video default. Setting OPT5 will swap Computer1 and Computer2.

- OPT7 handshake mode is NOT available, but Power on connection blink codes available;
- Turn off the auto-input-source feature;

**RS232 connections to Ricoh with DB9 connector. Mini-USB pinout not known**

These use a 9-pin-D9 male on the projector, female on cable. Comms is at 9600/115k baud, 8 bits, no parity, 1 stop.

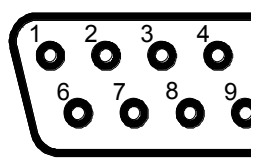
Function/Direction	T440 “projector” Connection	“Serial” Port Connector	 <p>D-sub 9 female</p>
Ground	Ground	9-pin D-sub pin 5	
Data from T440 to projector	Tx	9-pin D-sub pin 3	
Reply data from projector to T440	Rx	9-pin D-sub pin 2	
Plus 9 volt CTS/DTR to projector	N/C	N/C	

After installation wiring of any projector to a T440, use a multimeter to check voltages of -9 on BOTH TX and RX pins in any installation, as described in the troubleshooting part of this manual.

## Sharp, EIKI EIP projectors (Code 20, 21, 22 , absolute audio)

This family has many members with a range of channel messages. Following are current models:

Sharp has RS232 code charts at the back of the Operation Manual for each projector.

**Code 20: PG-D2500X, PG-D2510X, PG-D2710X, PG-D3010X, PG-D3510X, XR-50S, XR55X (VGA(1)/Vid/S-Vid) PG-F212X, PG-F262X, PG-F312X, PG-LS2000, PG-LX2000 Eiki EIP-250, EIP2600, (VGA (R1), HDMI/DVI (R2), (Vid V1, some S-Vid V1, Vid V2)**

**Code 21: PG-D2870W, PG-D3050W, PG-D3550W, PG-D40W3D, XG-SV100W, XG-SV200X (VGA R1/2, HDMI(R3), Vid(V1), S-Vid(V2))**

**Code 21: XG-P560W/N, Eiki EIP-WX5000, (VGA(R1), BNC(R2), DVI(R3), HDMI(R4),Vid, S-Vid) PG-D45X3D, PG-D50X3D (VGA (1), DVI-D/A (2), Vid(V1), S-Vid(V2)**

**Code 22: XVZ17000, XV-Z30000 (VGA(R1), RCA Comp(R2),Vid (V1),S-Vid (V2), HDM1/2 (R3/4)**

Channel codes are:

```

Input1 := 'IRGB 1' + 0D; //Computer1 RGB 1 VGA analog-RGB
Input2 := 'IRGB 2' + 0D; //Computer2 RGB 2 VGA analog, BNC(some only), RCA comp,
                        DVI PG-D45/50X3D, HDMI PG-LS/LX2000

Input3 := 'IVED 1' + 0D; //Video1 Comp Video/S-Video / Component 1
Code 20: Input4 := 'IVED 2' + 0D; // S-Video
Code 21: Input4 := 'IRGB 3' + 0D; // DVI-D, HDMI. HDMI-1
Code 22: Input4 := 'IRGB 4' + 0D; // HDMI, HDMI-2

Input5 := 'IVED 3' + 0D; // Comp Video 2
Input6 := 'IVED 4' + 0D; // S-Video 2

Input7 := 'IVED 5' + 0D; // RGB/COMPONENT on SHARP DT-400, XV-Z2000, EIKI EIP-1500
Input8 := 'IVED 6' + 0D; // DIGITAL MODE on SHARP DT-400, XV-Z2000, EIKI EIP-1500
Input9 := 'ISEV 1' + 0D; // S-VIDEO on EIKI_EIP_S200/X200/X350
Input10 := 'ICMP 1' + 0D; // COMPONENT on EIKI_EIP_S200/X200/X350

Input11 := 'IDVI 1' + 0D; // DVI on EIKI_EIP_S200/X200/X350
Input12 := 'IRGB 3' + 0D; // DVI (XGP560W/N, Eiki WX5000) or HDMI (PG-D2870W,
                        PG-D3050W, PG-D3550W) HDMI-1 (XVZ17000/3000)
Input13 := 'IRGB 4' + 0D; // HDMI XGP560W/N, Eiki WX5000 HDMI-2 (XVZ17000/30000)
    
```

Any one of these codes can be set into Constant:0/Constant:1 for computer codes and Constant:2/Constant:3 for video codes. (The default is to have Computer1 (above) as the “Computer” channel and Video1 as the “Video” channel. Setting OPT1 switch ON will swap Video1 and Video2 channels, making S-Video the video default. Setting OPT5 will swap Computer1 and Computer2. Setting OPT4 will allow double- presses on some keyboards.).

- Some models use IVED1 for Comp Video, and IVED2 for S-Video, and some use the reverse;
- In the “Standby mode” menu disable “Eco” mode and select “Quick Start”;
- OPT7 handshake mode and power on panel connection blink codes available.

## RS232 connections to Sharp/Eiki projectors

These use a D-sub 9-pin connector, female or male on cable: (May be via an adaptor cable from projector 9-pin mini-DIN) Communications is at 9600 baud 8N1. Some projectors may need this to be set up via an on-screen menu.

Function/Direction	T440 “projector” Connection	Sharp Control Port Connector, D-sub 9	Sharp Control Port Connector DIN 9
Ground	Ground	9-pin D-sub pin 5	9-pin D-sub pin 5
Data from T440 to projector	Tx	9-pin D-sub pin 2	9-pin D-sub pin 2
Reply data from projector to T440	Rx	9-pin D-sub pin 3	9-pin D-sub pin 3
Plus 9 volt CTS/DTR to projector	CTS	unused	unused

## Smart projector family, e.g. SLR40wi (code 7A), UF75, UX60, INIFI UF55/w, (Code 7B )

Manuals are at:

SLR40wi:

<http://smarttech.com/Support/Browse+Support/Product+Index/Hardware+Products/SMART+Interactive+Projectors/40wi>

UF75: <http://smarttech.com/supportSB600i5> UX60: <http://smarttech.com/supportSB600ix>

UF55/UF55w:

[http://downloads01.smarttech.com/media/sitecore/en/support/product/smartboardsfpd/600i3sbd600i3series/guides/guide\\_sb\\_sbd600i3v25nov09.pdf](http://downloads01.smarttech.com/media/sitecore/en/support/product/smartboardsfpd/600i3sbd600i3series/guides/guide_sb_sbd600i3v25nov09.pdf)

Channel codes are:

Input1 := 'set input=vga1' + 0D; //Computer 1: Input 1: DB15

Input2 := 'set input=vga2' + 0D; //Computer 2: Input 2: DB15

Input3 := 'set input=composite' + 0D; //Video1 ; //Video1 \*OPT1 ON will use HDMI as Video 1

Input4 := 'set input=HDMI' + 0D; //Video2 HDMI (**some only**)

\* T440: Setting OPT6 switch to ON will use S-Video in place of HDMI, and

Input4 := 'set input=s-video' + 0D; //Video2 S-video. T430: Uses HDMI for Video2

Input5 := 'set input=s-video' + 0D;

Input6 := 'set input=HDMI' + 0D;

Any one of these codes can be set into Constant:0/Constant:1 for computer codes and Constant:2/Constant:3 for video codes. (The default is to have Computer1 (above) as the “Computer” channel and Video1 as the “Video” channel. Setting OPT1 switch ON will swap Video1 and Video2 channels. Setting OPT5 switch ON will swap Computer 1 and Computer 2 sources.)

- Mute or Freeze functions are supported on SLR40wi and UF75 and UX60. Others not supported.
- OPT7 handshake mode and power on panel connection blink codes available.

## RS232 connections to Smart Projectors

These use a 9-pin-D9 male on the projector, male on cable. Communications is at 9600 baud 8N1.

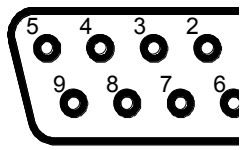
Function/Direction	T440 “projector” Connection	Smart “Control” Port Connector	 <p>D-sub 9 male</p>
Ground	Ground	9-pin D-sub pin 5	
Data from T440 to projector	Tx	9-pin D-sub pin 3 (RXD)	
Reply data from projector to T440	Rx	9-pin D-sub pin 2 (TXD)	
Plus 9 volt CTS/DTR to projector	N/C	N/C	

After installation wiring of any projector to a T440, use a multimeter to check voltages of -9 on BOTH TX and RX pins in any installation, as described in the troubleshooting part of this manual.

## Sony (Code 08, Even Parity, Code 09 No Parity)

Even parity **All Code 08** : SONY VPL-BW5, **VPL-C200 series**, VPL-CW125, VPL-CW255, VPL-CW258, VPL-CW275, VPL-CW278, VPL-CX61, VPL-CX63, VPL-CX80, VPL-CX85, VPL-CX86, VPL-CX100, VPL-CX120, VPL-CX125, VPL-CX130, VPL-CX131, VPL-CX135, VPL-CX150, VPL-CX155, VPL-CX160, VPL-CX161, VPL-CX165, VPL-CX235, VPL-CW238, VPL-CX275, VPL-CX278, VPL-ES4, VPL-DW125, VPL-DX125, VPL-DX145, **VPL-E200 Series**, VPL-EW7, VPL-EW130, VPL-EW225, VPL-EW226, VPL-EW245, VPL-EW246, VPL-EW275, VPL-EW276, VPL-DW125, VPL-DX125, VPL-DX145, VPL-EX4, VPL-EX5, VPL-EX7, VPL-EX50, VPL-EX70, VPL-EX71N, VPL-EX100, VPL-EX101, VPL-EX120, VPL-EX121, VPL-EX123, VPL-EX130, VPL-EX145, VPL-EX146, VPL-EX147, VPL-EX148, VPL-EX175, VPL-EX176, VPL-EX178, VPL-EX221, VPL-EX222, VPL-EX225, VPL-EX226, VPL-EX241, VPL-EX242, VPL-EX245, VPL-EX246, VPL-EX271, VPL-EX272, VPL-EX273, VPL-EX274, VPL-EX275, VPL-EX276, VPL-F400H/X , VPL-F401H, VPL-F500H, VPL-F501H , VPL-F600X, VPL-F700HL/XL, VPL-FE40, VPL-FH30, VPL-FH31, VPL-FH35, VPL-FH36, VPL-FH300L, VPL-FH500L, VPL-FW41/L, VPL-FW300L, VPL-FX30, VPL-FX35, VPL-FX37, VPL-FX40, VPL-FX41/L, VPL-FX50, VPL-FX51, VPL-FX52, VPL-FX500L, VPL-HW15, VPL-HW30, VPL-HW50, VPL-PX11, VPL-PX15, VPL-PX35, VPL-PX40, VPL-PX41, **VPL-S200 series, VPL-S500 series, VPL-S600 series**, VPL-SW125, VPL-SW525/C, VPL-SW526/C, VPL-SW535/C, VPL-SX125, VPL-SX525, VPL-SX535, VPL-TX7, VPL-TX70, VPL-VW70, VPL-VW85, VPL-VW95, VPL-VW200, VPL-VW1000.

No parity: VPL-ES3/EX3: **Code 09**

Protocol manuals are not generally on line in Australia, but can be ordered from Sony directly. Often using Google with the string containing the projector model no such as: **VPL-EX225 "protocol manual"** will fetch one.

This family has common codes, but allocates the “Inputs A/B/C/D/E/F” differently.

Channel codes are:

Input1 := A9 + 00 + 01 + 00 + 00 + 02 + 03 + 9A; //Computer1 Input A: VGA  
 Input2 := A9 + 00 + 01 + 00 + 00 + 03 + 03 + 9A; //Computer2 Input B: VGA 2 or Component or HDMI  
 Input3 := A9 + 00 + 01 + 00 + 00 + 00 + 01 + 9A; //Video1 Composite Video RCA  
 Input4 := A9 + 00 + 01 + 00 + 00 + 01 + 01 + 9A; //Video2 S-Video  
 Input5 := A9 + 00 + 01 + 00 + 00 + 04 + 05 + 9A; // Input C or HDMI  
 Input6 := A9 + 00 + 01 + 00 + 00 + 05 + 05 + 9A; // Input D or DVI or USB (Type B)  
 Input7 := A9 + 00 + 01 + 00 + 00 + 06 + 07 + 9A; // Input E Network  
 Input8 := A9 + 00 + 01 + 00 + 00 + 07 + 07 + 9A; // Input F USB (Type A)

Any one of these codes can be set into Constant:0/Constant:1 for computer codes and Constant:2/Constant:3 for video codes. (The default is to have Computer1 (above) as the “Computer” channel and Video1 as the “Video” channel. Setting OPT1 switch ON will swap Video1 and Video2 channels, making S-Video the video default. Setting OPT5 will swap Computer1 and Computer2. Setting OPT4 will allow double- presses on some keyboards.).

- OPT7 handshake mode and power on panel connection blink codes available;
- Pressing a “Computer” channel key when already selected will instead send a Auto Pixel Align whenever needed;
- Setting OPT2 switch ON will send an Auto Pixel Align message 30 seconds after selecting a computer channel;
- Picture and sound mute is available with two-yellow-button mute mode, but no Freeze is available.

## RS232 connections to Sony projectors and LCD flat panel

These all use a D-sub 9-pin connector, male on cable. All use Even parity, 1 stop except: VPL- ES3/EX3, 38400 BAUD, which uses: No parity, 1 stop.

Function/Direction	T440 “projector” Connection	Projector Connector (Male on cable)
Ground	Ground	9-pin D-sub pin 5
Data from T440 to projector	Tx	9-pin D-sub pin 2 (RXD)
Reply data from projector to T440	Rx	9-pin D-sub pin 3 (TXD)
Plus 9 volt CTS/DTR to projector	N/C	N/C

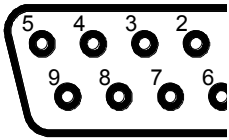

D-sub 9 mal

After installation wiring of any projector to a T440, use a multimeter to check voltages of -9 on BOTH TX and RX pins in any installation, as described in the troubleshooting part of this manual.

## Sony (Code 0A, Even Parity, ADCP Alpha protocol)

(It seems that current Sony projectors are controllable both by the binary codes above or this driver's alphanumeric sequence.)

Channel codes are:

```
Input1 := 'input "rgb2"' + 0D + 0A; // Input B VGA
Input2 := 'input "hdmi2"' + 0D + 0A; //Computer2 HDMI 2
Input3 := 'input "video1"' + 0D + 0A; //Video1 Composite Video RCA
Input4 := 'input "hdmi1"' + 0D + 0A; // Digital HDMI
```

\* T440: OPT6 switch ON will use S-Video in place of HDMI 1. T430: uses HDMI for User2

```
Input4 := 'input "svideo1"' + 0D + 0A; // S-Video
Input5 := 'input "rgb2"' + 0D + 0A; // Input B VGA
Input6 := 'input "dvi1"' + 0D + 0A; // Digital DVI
Input7 := 'input "network"' + 0D + 0A; // Network
Input8 := 'input "usb_a"' + 0D + 0A; // USB (type A)
Input9 := 'input "usb_b"' + 0D + 0A; // USB (type B)
Input10 := 'input "hdbaset1"' + 0D + 0A; // HDBaseT terminal 1
Input11 := 'input "option1"' + 0D + 0A; // Option adapter 1
```

Any one of these codes can be set into Constant:0/Constant:1 for computer codes and Constant:2/Constant:3 for video codes. (The default is to have Computer1 (above) as the “Computer” channel and Video1 as the “Video” channel. Setting OPT1 switch ON will swap Video1 and Video2 channels, making S-Video the video default. Setting OPT5 will swap Computer1 and Computer2. Setting OPT4 will allow double- presses on some keyboards.).

- OPT7 handshake mode and power on panel connection blink codes available;
- Picture and sound mute is available with two-yellow-button mute mode, and Freeze is also available.

## Sony IR controlled projectors, (codes A8, A9, AA )

This family uses Infrared communications with the projector (at 40Khz) via a stick-on “bug” IR transmitter placed over the IR window on the back of the projector. This family of projectors all use the 15-bit Sony protocol.

It simulates the IR codes sent by the hand-held remote control. Three drivers are provided, and their use depends on what level of IR is provided in the projector.

**All Sony projector protocol manuals include a 128-entry IR code table, but do NOT specify which projectors are covered by what codes. JED has tested a VPL-DX120, and found that it only responds the common power command (15hex, same for On and Off) rather than the discrete codes in the tables, and it only accepts the rolling “Input Toggle” for source selection and NOT the discrete commands for “Video”, “Input A” through “Input F”. Thus we have provided three drivers, the first, simplest one for common power commands and rolling “Input toggle”, and the other two with discrete commands as detailed below.**

**Code A8: (VPL-DW120, VPL-DX120, VPL-DX140)** is the simplest, and must use a Code 1 keyboard, as there is only provision for an Input Toggle command, (57hex called “Source” on the Code 1 keyboard). This keyboard also provides volume up and down. As the “Source” button is pressed once, the on-screen menu appears on the projected image, and pressing it again (and again) scrolls the selection through provided sources. Leaving it on a selection for a few seconds switches to that source, and the menu disappears.

The red LED comes on immediately on power up with no flashes, and the green LED flashes during warmup and glows continuously in the ON state. Pressing the OFF button sends the “POWER” IR message once and the red LED blinks during the cool-down time, then glows steadily. (Ignore the “press again to resume” message.)

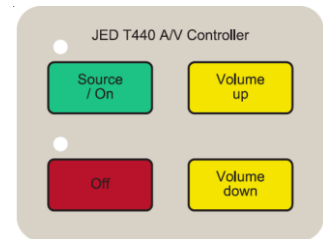

Code 1 T440 keyboard

The projector will start on the same source channel it was displaying when switched OFF.

The “Code 1” keyboard provides incremental volume Up/Down keys, and the current volume level is shown on the projected image for a few seconds. The volume has a 0 -> 100 range, and the T440 is programmed to quickly send five successive Increment or Decrement commands at 200ms intervals, so only 20 presses are needed to cover the range. Holding a volume key down auto-increments the volume.

The red and green LEDs follow the current state of the projector. If the projector gets out of step with the controller (e.g. by the projector being ON when the red OFF led is showing), pressing the ON button will get it back into step, and then pressing OFF once will send the “POWER” IR message, leaving both OFF.

Because there is no feedback serial path to the controller, OPT7 status read-back is not possible. (Freeze and mute are not supported. Two-button-mute mode is not supported either.) Leave all option switches OFF.

**Wiring: See discussion of IR wiring under Epson IR on pages 15 and 16.**

### Code A9, Code AA: Sony projectors with IR-selection of sources.

(Code A9 has common power on/off code 15 , Code AA has discrete codes, 2E for On, 2F for Off)

These codes provide more control via IR than code A8 above, in that there are individual buttons for Video, and Input A through Input F.

The drivers are suitable for use with the Code 0 (just On/Off Computer and Video), and Code 9 (with Volume Up/Down) Option4 switch can be used.

Input1FunctionCode	:= \$2B; // Computer1	VGA	INPUT A
Input2FunctionCode	:= \$2C; // Computer2	HDMI	INPUT B (on both second Computer and second Video)
Input3FunctionCode	:= \$2A; // Video1	VIDEO: RCA	*(OPT1 swaps Video1 & Video2)
Input4FunctionCode	:= \$2C; // Video2	HDMI	INPUT B (on both second Computer and second Video)

\* T440: Setting OPT6 switch to ON will use S-Video in place of HDMI:

Input4FunctionCode	:= \$5F; // Video2	S-Video	
Input5FunctionCode	:= \$6F; //	INPUT C	
Input6FunctionCode	:= \$70; // USB	INPUT D	
Input7FunctionCode	:= \$71; // LAN	INPUT E	
Input8FunctionCode	:= \$06; //	INPUT F	



## Toshiba (Codes 50 to 57 )

A good collection of protocol manuals is at:

<http://www.isd.toshiba.com.au/projectors/projectors/service-manuals.shtml>

**Code 50: (Group 1.1):** TLP-S200/S201/S220/S221, TLP-T400/T401, TLP-T500/T501/T520/T521, TLP-T600/T601/T620/T621, and TLP-T700/T701/T720/T721;

**Code 51 (Group 1.2):** TDP-MT200/MT400;

**Code 51 (Group 1.3):** TDP-S20/S21/SC21/S25/SC25/SW25/S35/SC35/SW35, TDP-S80/SW80/S81/T90/TW90/T91/T99/TW99, and TLP-710/711;

**Code 51 (Group 1.4):** TDP-S8/S10, SW20, TDP-T8/T9/T30/T40/T45/T80/T98, TLP-250/251/260/261/380/381/550/551/560/561/780/781/790/791, TLP-MT7E, TLP-X10U/11U/20U/21U;

**Code 51 (Group 1.5):** TDP-D1/D2, TLP-S30/S40/S41/S70/S71, and TLP-T50/T60/T61/T70/T71;

**Code 52 (Group 1.6):** TLP-450/451/470/471/650/651/670/671/680/681/, TLP-B2/U (RGB set only Ch 1).

	<b>Group 1.1 Code 50</b>	<b>Group 1.2 Code 51</b>	<b>Group 1.3 Code 51</b>	<b>Group 1.4 Code 51</b>	<b>Group 1.5 Code 51</b>	<b>Group 1.6 Code 52</b>
Input1 / (Computer1)	STX IN1 ETX (RGB1)	STX IN1 ETX (RGB1)	STX IN1 ETX (RGB1)	STX IN1 ETX (RGB1)	STX IN1 ETX (RGB1)	STX IN1 ETX (RGB)
Input2 / (Computer2)	STX IN3 ETX (RGB2)	STX IN2 ETX (DVI)	STX IN2 ETX (RGB2)	STX IN2 ETX (RGB2)		
Input3 / (Video1)	STX IN5 ETX (Video)	STX IN3 ETX (Video)	STX IN3 ETX (Video)	STX IN3 ETX (Video)	STX IN3 ETX (Video)	STX IN2 ETX (Video)
Input4 / (Video2)	STX IN6 ETX (S-Video)	STX IN4 ETX (S-Video)	STX IN4 ETX (S-Video)	STX IN4 ETX (S-Video)	STX IN4 ETX (S-Video)	STX IN3 ETX (S-Video)
Input5	STX IN2 ETX (YPbPr1)				STX IN2 ETX (YPbPr)	
Input6	STX IN4 ETX (YPbPr2)	STX IN5 ETX (YPbPr )	STX IN5 ETX (Camera )	STX IN5 ETX (PC card )	STX IN5 ETX (Camera )	
Input7	STX IN7 ETX (PC card)		STX IN6 ETX (Network)	STX IN6 ETX (Camera)		
Input8	STX IN8 ETX (Camera)					

(Group 2, 3 next page.)

**Code 54 (Group 2.1): TDP-T/TW95, T/TW100,**

**Code 54 (Group 2.2): TLP-X2000/XC2000/XD2000, TLP-X2500/XC2500, TLP-X3000/XC3000, TLP-WX2200, TDP-T250/TW250, TDP-T300/TW300, TDP-T350/TW350, TDP-T355/TW355**

**Code 55 (Group 2.3): TDP-ST20, TDP-EX20, TDP-EW25**

**Code 56 (Group 3): TLP-X100, X150, X200, WX100, WX200**

**Code 57 (Group 4): TDP-SP1, XP1, XP2**

**Note: This group not certified for reliable operation yet. Does not support OPT7 handshake.**

	<b>Group 2.1 Code 54</b>	<b>Group 2.2 Code 54</b>	<b>Group 2.3 Code 55</b>	<b>Group 3 Code 56</b>	<b>Group 4 Code 57</b>
Input1 / (Computer1)	STX IN3 ETX (RGB 1 or DVI-A)	STX IN3 ETX (RGB1)	STX IN3 ETX (RGB1)	#INP:1 <0D> (RGB1)	#INP:3 <0D> (RGB1)
Input2 / (Computer2)	STX IN5 ETX (RGB2)	STX IN5 ETX (RGB2)	STX IN5 ETX (RGB2)	#INP:3 <0D> (RGB2)	
Input3 / (Video1)	STX IN9 ETX (Video)	STX IN9 ETX (Video)	STX IN9 ETX (Video)	#INP:9 <0D> (Video)	#INP:9 <0D> (Video)
Input4 / (Video2)	STX INA ETX (S-Video)	STX INA ETX (S-Video)	STX INA ETX (S-Video)	#INP:10 <0D> (S-Video) *	#INP:10 <0> (S-Video)
Input5	STX IN4 ETX (YPbPr1)	STX IN4 ETX (YPbPr1)	STX IN4 ETX (YPbPr1)	#INP:2 <0D> (YPbPr1)	
Input6	STX IN6 ETX (YPbPr2)	STX IN6 ETX (YPbPr2)	STX IN6 ETX (YPbPr2)	#INP:4 <0D> (YPbPr2)	
Input7	STX IN8 ETX (BNC3/YPbPr3)			#INP:5 <0D> (HDMI) *	
Input8		STX INB ETX (Camera)		#INP:12 <0D> (Network)	
Input9		STX INC ETX (PC card)	STX INC ETX (Network)		
Input10	STX IND ETX (USB/Wireless)		STX IND ETX (USB/Wireless)		

\* T440: Setting OPT6 switch to ON will use HDMI code INP:5 in place of S-Video INP:10 , and OPT1 ON will then use HDMI as Video 1. T430: Uses HDMI for Video 2

Any one of these codes can be set into Constant:0/Constant:1 for computer codes and Constant:2/Constant:3 for video codes. (The default is to have Computer1 (above) as the “Computer” channel and Video1 as the “Video” channel. Setting OPT1 switch ON will swap Video1 and Video2 channels, making S-Video the video default. Setting OPT5 will swap Computer1 and Computer2. Setting OPT4 will allow double- presses on some keyboards.).

- Power on panel connection blink codes are provided, and OPT7 handshake mode is available;
- Auto Pixel Align is NOT available;
- Picture and sound mute is available with two-yellow-button mute mode with a “volume” keyboard;
- Mute and freeze keyboard code A available;
- Make sure to turn off “Auto input search” in the “Default setting” menu page of the projector.

## RS232 connections to Toshiba projectors

Most use a male 8-pin mini-DIN. is at 9600 baud, 8 bits, no parity, 1 stop.

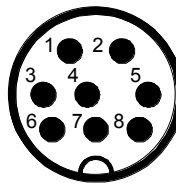
Function/Direction	T440 "projector" Connection	"Serial" Port Connector	
Ground	Ground	8-pin mini-DIN pin 4	 <p>Mini-DIN C</p>
Data from T440 to projector	Tx	8-pin mini-DIN pin 1 RXD)	
Reply data from projector to T440	Rx	8-pin mini-DIN pin 7 TXD)	
Plus 9 volt CTS/DTR to projector	N/C	N/C	

**After installation wiring of any projector to a T440, use a multimeter to check voltages of -9 on BOTH TX and RX pins in any installation, as described in the troubleshooting part of this manual.**

## RS232 connections to Toshiba with D9

These use a 9-pin-D9 male on the proj, female on cable. Comms is at 9600 baud, 8 bits, no parity, 1 stop.

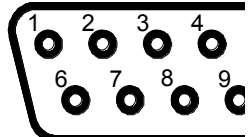
Function/Direction	T440 "projector" Connection	"Serial" Port Connector	
Ground	Ground	9-pin D-sub pin 5	 <p>D-sub 9 female</p>
Data from T440 to projector	Tx	9-pin D-sub pin 3 (RXD)	
Reply data from projector to T440	Rx	9-pin D-sub pin 2 (TXD)	
Plus 9 volt CTS/DTR to projector	n/c	n/c	

**After installation wiring of any projector to a T440, use a multimeter to check voltages of -9 on BOTH TX and RX pins in any installation, as described in the troubleshooting part of this manual.**

## Taxan Kaga- Plus projector families: (Code 40..43) KG-PV-131S/X/Xh, KG-PS-232X/Xh

Channel codes are:

```

Input1 := '#SA' + 0D + 0A; //Computer1 RGB 1 VGA analog-RGB
Input2 := '#SB' + 0D + 0A; //Computer2 RGB 2 VGA analog-RGB2 on U7, DVI on some
Input3 := '#SV' + 0D + 0A; //Video1 Comp Video
Input4 := '#SS' + 0D + 0A; //Video2 S-Video
    
```

Any one of these codes can be set into Constant:0/Constant:1 for computer codes and Constant:2/Constant:3 for video codes. (The default is to have Computer1 (above) as the "Computer" channel and Video1 as the "Video" channel. Setting OPT1 switch ON will swap Video1 and Video2 channels, making S-Video the video default. Setting OPT5 will swap Computer1 and Computer2. Setting OPT4 will allow double- presses on some keyboards.).

- OPT7 handshake mode and power on connection blink codes available;
- Turn off the auto-source feature;
- Freeze and blank (toggle) are supported (keyboard code A), and any non-volume keyboard; and
- Absolute mute is not supported, so even if using a T441/461, absolute video mute is not available.

## RS232 connections to Kaga -Taxan - Plus projectors

These use a 9-pin-D9 male on the projector, female on cable. Comms is at 19200 baud, 8 bits, no parity, 1 stop.

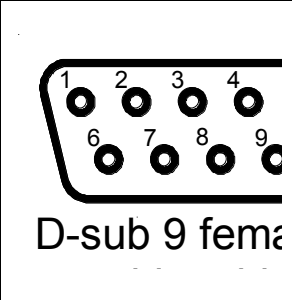
Function/Direction	T440 "projector" Connection	"Serial" Port Connector	
Ground	Ground	9-pin D-sub pin 5	
Data from T440 to projector	Tx	9-pin D-sub pin 3	
Reply data from projector to T440	Rx	9-pin D-sub pin 2	
Plus 9 volt CTS/DTR to projector	N/C	N/C	

After installation wiring of any projector to a T440, use a multimeter to check voltages of -9 on BOTH TX and RX pins in any installation, as described in the troubleshooting part of this manual.

### Baud rate change

This family of projectors can be operated at 115,200 baud or 19,200 baud. As shipped from Kaga/Taxan, communications is at 115,200 baud, and **must be set to 19,200 for use with a T440 to get reasonable wiring length.**

**A built-in baud rate changer is incorporated as dummy channels in the T430/T440, using codes 41 and 42 .** In operation, selecting code 43 will control the projector at 115200 (not recommended for install). Use 40 for install to run at 19200 baud.

Switch to 19,200 as follows:

Wire to the projector via a short cable (in the workshop). Set code 43 and verify the projector operates ok at 115200 baud (One red blink then steady, On, Off, channels working OK)

Set a projector code of address of 41 , and reset the T440 with the reset switch.

The red OFF LED will come on steady.

Press the/an ON button. The #CL<CR><LF> baud rate change command is sent to the projector.

Set a projector code of 40 , and reset the T440 with the reset switch. Check the operation at 19200: (One red blink then steady, On, Off, channels working OK) **It is ready for use.**

(If the projector needs to be reset to operate at 115200, set code 42 and reset the T40. The red OFF led will come on steady. Press the/an ON button. The #CH<CR><LF> baud rate change command is sent to the projector.

Set code 43 and Reset the T440, and verify the projector operates ok at 115200 baud (One red blink then steady, On, Off, channels working OK) The baud rate is held in projector non-volatile memory, so the baud rate setting to 19,200 need be done only once.

## Taxan Kaga- projector families: (Code 60...63) KG-PS-101S/121X, KG-PD121X

Channel codes are:

```
Input1 := '04FB' + 0D + 0A; //Computer1 RGB 1 VGA analog-RGB
Input3 := '03FC' + 0D + 0A then '5FA0' + 0D + 0A then '17E8' + 0D + 0A //Video1 enters video mode,
then needs "up arrow" and "enter".
```

The switching to, and selection of, a Video channel involves simulating pressing three buttons in sequence on an IR remote control, with controlled delays between the strings of 750ms. We do this by sending codes for "Video", then "Up Arrow" (to toggle to the alternate video channel) and then sending an "Enter" code.

This method allows a T440 with a single "Computer" button, or a T440 with one "Computer" button and one "Video" button to be used. Even with one "Video" button, it allows access to both Video and S-Video sources. DO NOT set OPT4, which is normally needed to allow toggle between two sources ... toggling is automatic in this driver.

Audio is limited to one input and no output. If control is needed to external speakers, use a T441.

- Power on connection blink codes are available;
- Turn off the auto-source search feature;
- Freeze and blank (toggle) are supported (keyboard code A), and any non-volume keyboard; and

Absolute mute is not supported, so even if using a T441/461, absolute video mute is not available.

The T430 is also supported, in either “Computer” or “Video” modes:

- It supports a single “Computer” channel keyboard (no OPT switches ON). Use a KB1 keyboard (On/Off);
- With “Video” channels selected (OPT8 ON), and use a KB3 (OFF, On/Source) keyboard and the “ON” button toggles between the two video sources.

## RS232 connections to Kaga -Taxan - Plus projectors

These use a 9-pin-D9 male on the projector, female on cable. Comms is at 19200 baud, 8 bits, no parity, 1 stop.

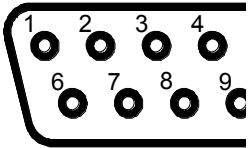
Function/Direction	T440 “projector” Connection	“Serial” Port Connector	 <p>D-sub 9 female</p>
Ground	Ground	9-pin D-sub pin 5	
Data from T440 to projector	Tx	9-pin D-sub pin 3	
Reply data from projector to T440	Rx	9-pin D-sub pin 2	
Plus 9 volt CTS/DTR to projector	N/C	N/C	

After installation wiring of any projector to a T440, use a multimeter to check voltages of -9 on BOTH TX and RX pins in any installation, as described in the troubleshooting part of this manual.

## Baud rate change

This family of projectors can be operated at 115,200 baud or 19,200 baud. As shipped from Kaga/Taxan, communications is at 115,200 baud, and **must be set to 19,200 for use with a T440 to get reasonable wiring length.**

**A built-in baud rate changer is incorporated as dummy channels in the T430/T440, using codes 61 and 62 .** In operation, selecting code 63 will control the projector at 115200 (not recommended for install). Use 60 for install to run at 19200 baud.

Switch to 19,200 as follows:

Wire to the projector via a short cable (in the workshop). Set code 63 and verify the projector operates ok at 115200 baud (One red blink then steady, On, Off, channels working OK)

Set a projector code of address of 61 , and reset the T440 with the reset switch.

The red OFF LED will come on steady.

Press the/an ON button. The #CL<CR><LF> baud rate change command is sent to the projector.

Set a projector code of 60 , and reset the T440 with the reset switch. Check the operation at 19200: (One red blink then steady, On, Off, channels working OK) **It is ready for use.**

(If the projector needs to be reset to operate at 115200, set code 62 and reset the T40. The red OFF led will come on steady. Press the/an ON button. The #CH<CR><LF> baud rate change command is sent to the projector.

Set code 63 and Reset the T440, and verify the projector operates ok at 115200 baud (One red blink then steady, On, Off, channels working OK) The baud rate is held in projector non-volatile memory, so the baud rate setting to 19,200 need be done only once.

(Toshiba was here, covered with codes 56 and 57.)

## ViewSonic projector families: (Code 5C, 5D, 5E )

PJD5112, PLD6210/11/12, PLD6220/1, PJD6230, PJD6240/1, PJD6251, PJD6381, PJD6531w, PJ557D, PJ559D, PJ560D, Pro8450w, Pro8500, Pro8600 (**Codes 5C, 5D.**)

PJD5123, PJD5223, PJD5232, PJD5234, PJD7223, PJD6243, PJD5345, PJD6544w, PJD5353, PJD7333, PJD7533w, PJD8333s, PJD8633ws: All absolute Blank/Mute/Freeze. **Use code 5E.**

(For ViewSonic PJ510, PJ853, PJ656, PJ552, PJ562, PJ750, PJ862, PJ1165, PJ1172, PJ1065 ... see Hitachi, Code 44 )

(For ViewSonic PJ759/PJ758/PJ760, PJ1158 ... see Hitachi, Code 45 )

(For ViewSonic PRO-8100 ... see Sanyo PLC-WXU10N/E/B, Code 07 )

These (following) are Hitachi-like code structure, but are NOT Hitachi or Sanyo compatible.

Manuals usually list HEX strings but are NOT accurate ... eg several with obviously 2 RGB ports don't list codes for the second port, but have a string for HDTV which is YPbPr (Component). We provide two drivers with the choice of two options for the second Computer port. Also, the Component/HDMI/HDTV port (where provided) can be allocated to a Video 1 / 2 channel.

Channel codes are:

Input1 := BE + EF + 03 + 19 + 00 + 19 + 29 + 01 + 47 + 02 + CC + CC + 00; //Computer1 Analog RGB 1 DB15

Input2 := BE + EF + 03 + 19 + 1E + 90 + 72 + 01 + 47 + 02 + CC + CC + 00; //Computer2 Analog RGB 2 DB15  
**Code 5C**

or

Input2 := BE + EF + 03 + 19 + 00 + DA + 2B + 01 + 47 + 02 + CC + CC + 00; // Component,  
(HDMI: PJD6531w) (HDTV: PJ557/559/560)

**Code 5D**

Input3 := BE + EF + 03 + 19 + 00 + 78 + A8 + 01 + 47 + 02 + CC + CC + 00; //Video1 Composite Video RCA

Input4 := BE + EF + 03 + 19 + 00 + E8 + 69 + 01 + 47 + 02 + CC + CC + 00; //Video2 S-Video (Not PJD6210)

\* T440: Setting OPT6 switch to ON will use HDMI in place of S-Video, and OPT1 ON will then use HDMI as Video 1.  
T430: Uses HDMI for Video2.

Input5 := BE + EF + 03 + 19 + 00 + DA + 2B + 01 + 47 + 02 + CC + CC + 00; // Component Analog or HDMI  
(Also used as Input2, (Computer2) in Code 5D setting)

Any one of these codes can be set into Constant:0/Constant:1 for computer codes and Constant:2/Constant:3 for video codes. (The default is to have Computer1 (above) as the "Computer" channel and Video1 as the "Video" channel. Setting OPT1 switch ON will swap Video1 and Video2 channels, making S-Video the video default. Setting OPT5 will swap Computer1 and Computer2. Setting OPT4 will allow double- presses on some keyboards.).

### It is essential to set "Network" to "On" in the "Option" menu.

It is hidden below the normal screen and can be accessed by using the "down" arrow to scroll down further off screen after entering the "Option" menu. See last line in screen shot to the right.

Unless done, the projector only turns on once;

- Audio varies between units, often only one input and no output. If control is needed to external speakers, and multiple audio channels, use a JED T441 or T461 audio controller;
- Power off connection blink codes are available, as is OPT7 projector state monitoring);
- Turn off both the auto-source search feature and Eco mode.
- Absolute mute is not supported, so even if using a T441/461, absolute video mute is not available. Mute is limited to video modes only, if using a Code-A keyboard. Freeze is NOT supported.

(Connections follow.)

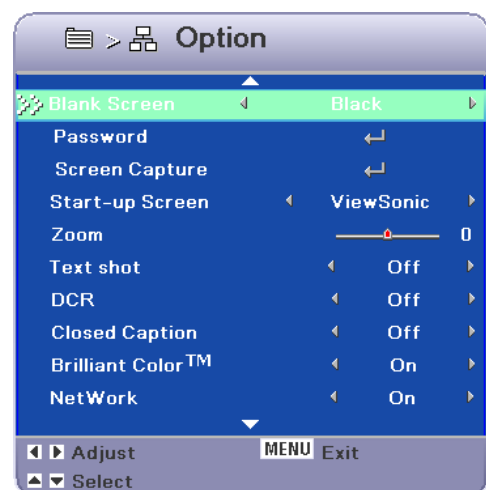

## ViewSonic projector families: (Code 5F )

Pro8200, Pro8300, Pro8400

These (following) are yet another Hitachi-like code structure, but are NOT Hitachi or Sanyo compatible.

Manuals with RS232 code charts are at: <http://www.viewsonic.com/> then enter projector model in search window, then go to product page, then select “downloads” and select “User guides”. The RS232 codes are in this manual.

Channel codes are:

Input1 := BE + EF + 02 + 06 + 00 + BC + D3 + 35 + 00 + 00 + 00 + 00 + 00; //Computer1 Analog RGB 1 DB15

Input2 := BE + EF + 02 + 06 + 00 + 8F + D3 + 36 + 00 + 00 + 00 + 00 + 00; //Computer2 Analog RGB 2 DB15

Input3 := BE + EF + 02 + 06 + 00 + A1 + D2 + 38 + 00 + 00 + 00 + 00 + 00; //Video1 Composite Video RCA\*

Input4 := BE + EF + 02 + 06 + 00 + 43 + D3 + 3A + 00 + 00 + 00 + 00 + 00; //Video 2 HDMI 1\*

\*(OPT1 swaps Video1 & Video2)

\* T440: OPT6 switch ON will use S-Video in place of HDMI/DVI. T430: Uses HDMI for Video2

Input4 := BE + EF + 02 + 06 + 00 + 70 + D3 + 39 + 00 + 00 + 00 + 00 + 00; //Video2 S-Video \*

Input5 := BE + EF + 02 + 06 + 00 + 5E + D2 + 37 + 00 + 00 + 00 + 00 + 00; // Component Analog

Input6 := BE + EF + 02 + 06 + 00 + 43 + D3 + 3A + 00 + 00 + 00 + 00 + 00; // HDMI 1

Input7 := BE + EF + 02 + 06 + 00 + 92 + D2 + 3B + 00 + 00 + 00 + 00 + 00; // HDMI 2

Any one of these codes can be set into Constant:0/Constant:1 for computer codes and Constant:2/Constant:3 for video codes. (The default is to have Computer1 (above) as the “Computer” channel and Video1 as the “Video” channel. Setting OPT1 switch ON will swap Video1 and Video2 channels, making S-Video the video default. Setting OPT5 will swap Computer1 and Computer2. Setting OPT4 will allow double- presses on some keyboards.).

- Audio varies between units, often only one input and no output. If control is needed to external speakers, and multiple audio channels, use a JED T441 or T461 audio controller;
- Power off connection blink codes are available; (OPT7 projector state monitoring is NOT available);
- Turn off the “Auto-source” search feature in the “Setting” menu;
- Mute and Freeze are supported (toggle mode), but absolute mute via 2 Volume keys pressed is NOT available. Code A keyboards are thus supported;
- There is no audio level indication on the projected image, which could be annoying.

## ViewSonic projector families: (Code 6C, 115200 baud, Code 07, 19200 baud )

PJD5126, PJD5226, PJD5226w, PJD6223, PJD6253, PJD6353, PJD6383, PJD6553w, PJD6653w, PJD6683w (HDMI), PJD6235/PJD6245/PJD6543w (HDMI), PJD8653ws/PJD8353s (HDMI) ultra-short throw.

PJD5111 PJD5351 (no HDMI), PJD5152 / PJD5352 (no HDMI), PJD5211/PJD5221/  
PJD5231/PJD5122 (no HDMI), PJD7383/ PJD7383i PJD7583w/PJD7583wi (no HDMI),  
PJD5211/PJD5221/ PJD5231/PJD5122 (no HDMI) (use OPT6 for S-Video on these)

These are a quite different code structure, more like Optoma or BenQ communicating at 115200 baud.

Manuals with RS232 code charts are at: <http://www.viewsonic.com/> then enter projector model in search window, then go to product page, then select “downloads” and select “User guides”, which have the RS232 codes.(not all accessible.)

Channel codes are:

Input1 := 06 + 14 + 00 + 04 + 00 + 34 + 13 + 01 + 00 + 60; //Computer1 Analog RGB 1 DB15

Input2 := 06 + 14 + 00 + 04 + 00 + 34 + 13 + 01 + 08 + 68; //Computer2 Analog RGB 2 DB15

Input3 := 06 + 14 + 00 + 04 + 00 + 34 + 13 + 01 + 05 + 65; //Video1 Composite Video RCA \*

Input4 := 06 + 14 + 00 + 04 + 00 + 34 + 13 + 01 + 03 + 63; //HDMI 1\*

\*(OPT1 swaps Video1 & Video2)

\* T440: OPT6 switch ON will use S-Video in place of HDMI/DVI. T430: Uses HDMI for Video2

Input4 := 06 + 14 + 00 + 04 + 00 + 34 + 13 + 01 + 06 + 66; //Video2 S-Video

Input5 := 06 + 14 + 00 + 04 + 00 + 34 + 13 + 01 + 07 + 67; // HDMI 2

Input6 := 06 + 14 + 00 + 04 + 00 + 34 + 13 + 01 + 09 + 69; // HDMI 3  
 Input7 := 06 + 14 + 00 + 04 + 00 + 34 + 13 + 01 + 0e + 6e; // HDMI 4  
 Input8 := 06 + 14 + 00 + 04 + 00 + 34 + 13 + 01 + 0a + 6a; // DVI  
 Input9 := 06 + 14 + 00 + 04 + 00 + 34 + 13 + 01 + 0b + 6b; // Component  
 Input10 := 06 + 14 + 00 + 04 + 00 + 34 + 13 + 01 + 0c + 6c; // HDBaseT  
 Input11 := 06 + 14 + 00 + 04 + 00 + 34 + 13 + 01 + 0f + 6f; // USB\_C  
 Input12 := 06 + 14 + 00 + 04 + 00 + 34 + 13 + 01 + 1a + 7a; // USB Reader  
 Input13 := 06 + 14 + 00 + 04 + 00 + 34 + 13 + 01 + 1b + 7b; // LAN / WiFi Display  
 Input14 := 06 + 14 + 00 + 04 + 00 + 34 + 13 + 01 + 1c + 7c; // USB Display

Any one of these codes can be set into Constant:0/Constant:1 for computer codes and Constant:2/Constant:3 for video codes. (The default is to have Computer1 (above) as the “Computer” channel and Video1 as the “Video” channel. Setting OPT1 switch ON will swap Video1 and Video2 channels, making S-Video the video default. Setting OPT5 will swap Computer1 and Computer2. Setting OPT4 will allow double- presses on some keyboards.).

- Audio varies between units, often only one input and no output. If control is needed to external speakers, and multiple audio channels, use a JED T441 or T461 audio controller.

Note: audio output MUST be enabled before use in the fifth menu, under “Audio” settings;

There is no audio level indication on the projected image, which could be annoying

- Power off connection blink codes are available, and OPT7 projector state monitoring is also provided;
- Turn off the “Quick Auto Source” search feature in the third menu;
- Mute and Freeze are supported as are absolute mute via 2 Volume keys pressed. Code 8 and A keyboards are supported;

### RS232 connections to ViewSonic projectors with D9 connectors

Following use D9 female on cable: PJD5112, PJD6211, PJD6212, PJD6221, PJD6241, PJD6251, PJD6381, PJD6531w, PJD7383/I, PJD7583w/wi, Pro8100, Pro8200, Pro8400.

Note: Connections are tested as below, NOT as in some manuals. \*

These use a 9-pin-D9 male on the projector, female on cable. (Coms is at 19200 baud, no parity, 1 stop.)

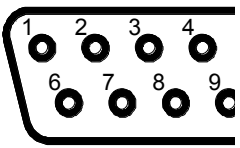
Function/Direction	T460 “projector” Connection	ViewSonic Control Port Connector D9	
Ground	Ground	9-pin D-sub pin 5	 <p>D-sub 9 female</p>
Data from T460 to projector	Tx	9-pin D-sub pin 2 *	
Reply data from projector to T460	Rx	9-pin D-sub pin 3 *	
Plus 9 volt CTS/DTR to projector	n/c	n/c	

After installation wiring of any projector to a T460, use a multimeter to check voltages of -9 on BOTH TX and RX pins in any installation, as described in the troubleshooting part of this manual.

### RS232 connections to ViewSonic projectors with DIN-8 connectors

Following use DIN8 connector: PJD6210/WH (Comms is at 19200 baud, 8 bits, no parity, 1 stop)

PJD5152, PJD5352, PJD5211, PJD5221, PJD5231, PJD5122 (Comms is at 115200 baud, 8 bits, no parity, 1 stop)

These use a mini-DIN 8 male connector wired, as follows:

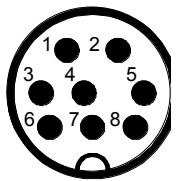
Function/Direction	T460 “projector” Connection	ViewSonic Control Port Connector DIN-8	
Ground	Ground	mini-DIN 8 pin 4	 <p>mini-DIN 8</p>
Data from T460 to projector	Tx	mini-DIN 8 pin 1 (RXD)	
Reply data from projector to T460	Rx	mini-DIN 8 pin 7 (TXD)	
Plus 9 volt CTS/DTR to projector	CTS	n/c	



## RS232 connections to ViewSonic projectors with DIN-6 connectors

Following use DIN6 connector: PJ557D, PJ559D, PJ560D, PJD6220, PJD6230, and PJD6240

The majority all use a mini-DIN 6 male connector wired, as follows: (Comms is at 19200 baud, 8 bits, no parity, 1 stop)

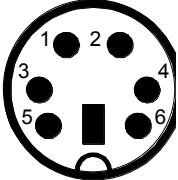
Function/Direction	T460 "projector" Connection	ViewSonic Control Port Connector DIN-6	
Ground	Ground	Mini-DIN Pins 1, 2	
Data from T460 to projector	Tx	Mini-DIN Pin 3 (RXD)	
Reply data from projector to T460	Rx	Mini-DIN Pin 5 (TXD)	
Plus 9 volt CTS/DTR to projector	n/c	n/c	

After installation wiring of any projector to a T460, use a multimeter to check voltages of -9 on BOTH TX and RX pins in any installation, as described in the troubleshooting part of this manual.

## ViewSonic PRO-8100 (Code 07),

This family has one member with just 5 channel messages. The ViewSonic has two HDMI channels, one replacing DVI-D of Sanyo.

There is an RS232 code chart at:

[http://www.slideandsound.com/pdf/sanyo/projectors/Owners\\_Manuals/om\\_PLC-WXU10N.pdf](http://www.slideandsound.com/pdf/sanyo/projectors/Owners_Manuals/om_PLC-WXU10N.pdf)

Channel codes are:

Input1 := BE + EF + 02 + 06 + 00 + 0B + D2 + 32 + 00 + 00 + 00 + 00 + 00; // Computer1 RGB 1 VGA

Input2 := BE + EF + 02 + 06 + 00 + 8F + D3 + 36 + 00 + 00 + 00 + 00 + 00; // Computer2 DVI-D/  
HDMI-1 in PRO-8100

Input3 := BE + EF + 02 + 06 + 00 + BC + D3 + 35 + 00 + 00 + 00 + 00 + 00; // Video1 Comp Video

Input4 := BE + EF + 02 + 06 + 00 + 6D + D2 + 34 + 00 + 00 + 00 + 00 + 00; //Video2 S-Video \*

\* T440: Setting OPT6 switch to ON will use HDMI in place of S-Video, and OPT1 ON will then use HDMI as Video1. T430: Use HDMI for Video2

Input5 := BE + EF + 02 + 06 + 00 + DA + D3 + 33 + 00 + 00 + 00 + 00 + 00; // Component (all)

Input6 := BE + EF + 02 + 06 + 00 + 85 + DA + 5C + 00 + 00 + 00 + 00 + 00; // Component 2 (PRO-8100 only)

Input7 := BE + EF + 02 + 06 + 00 + 5E + D2 + 37 + 00 + 00 + 00 + 00 + 00; // HDMI 2 (PRO-8100 only)

Any one of these codes can be set into Constant:0/Constant:1 for computer codes and Constant:2/Constant:3 for video codes. (The default is to have Computer1 (above) as the "Computer" channel and Video1 as the "Video" channel. Setting OPT1 switch ON will swap Video1 and Video2 channels, making S-Video the video default. Setting OPT5 will swap Computer1 and Computer2. Setting OPT4 will allow double- presses on some keyboards.).

- The "Input search" function MUST be disabled in the projector;
- Audio is limited: there is only one stereo RCA input, and NO audio output. There is control (incremental, 0->100 NOT 0->60 as the manual says) via the RS232 control if a "Volume" keyboard is used, but only to the rather weak internal speaker. Use a T441/T461 if better audio and switching is needed. The ViewSonic has no audio;
- Freeze and mute toggle only with the "Freeze/Mute" keyboards. No LEDs flash in the "Mute" state. No 2-yellow-button mute is provided with a "Volume" keyboard as the limited projector codes cannot command absolutely or read back the mute state. The ViewSonic has no freeze or blank command;
- Users can set OPT2 ON to enable sending Automatic Pixel Align 30 seconds after each Computer source transmission. The ViewSonic has no "Automatic Pixel Align" command;
- No "Projector Comms OK" message is available from the projector in Standby;
- No OPT7 handshake mode or power on panel connection blink codes are available, as no readback is provided.

## RS232 connections to Sanyo PLC-WXU10N

To connect the T440 to these projectors use a mini-DIN 6 male on the cable: Comms is at 19200 baud 8N1.

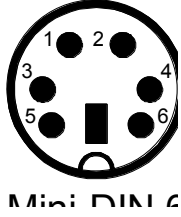
Function/Direction	T440 "projector" Connection	Projector Connector Connector 6-pin mini-DIN	
Ground	Ground	Mini-DIN Pins 1, 2	
Data from T440 to projector	Tx	Mini-DIN Pin 3 (RXD)	
Reply data from projector to T440	Rx	Mini-DIN Pin 5 (TXD)	
Plus 9 volt CTS/DTR to projector	N/C	N/C	

**Note: The signal input and output of this projector has clamp diodes and never goes below -0.7 volts or over +5.7 volts, even when connected to the T440.**

### RS232 connections to ViewSonic PRO-8100:

It would appear that the projector connection is a D9 connector. Connections and sex are not established.

### Vivitek (Code 2C, 2D, 2E), Promethean PRM-25, PRM-35, ESTP1 (code 2C)

(Message formats are ASCII with format: "~PN<CR>" for Power On, "~SR<CR>" for RGB select, etc.)

**Use Code 2C code for projectors with two VGA (RGB) inputs, e.g. D837, or one VGA and no HDMI, e.g. D82EX:**

Computer channel codes are:

```
Input1 := '~SR' + 0D; // Computer1 RGB 1 analog-RGB VGA
Input2 := '~SG' + 0D; // Computer2 RGB 2 analog-RGB VGA
```

**Use Code 2D code for projectors with one VGA (RGB) input and HDMI as second "Computer" input: E.g. D863, D925, D927, D930, D935, D940, D945, D963, H1080, D1085**

(Note: **Promethean** can also use Code 2D if VGA1 and HDMI are to be "Computer1" and "Computer2")

Computer channel codes are:

```
Input1 := '~SR' + 0D; // Computer1 RGB 1 analog-RGB VGA
Input2 := '~SD' + 0D; // Computer2 HDMI
```

Video channel codes (for both 2C and 2D ) are:

```
Input3 := '~SV' + 0D; //Video1 Comp Video *(OPT1 swaps Video1 & Video2)
Input4 := '~SH' + 0D; //Video2 HDMI* *(OPT1 swaps Video1 & Video2)
```

\*T440: OPT6 switch ON will use S-Video in place of HDMI. T430: uses HDMI for Video2

```
Input4 := '~SS' + 0D; //Video2 S-Video *
Input5 := '~SY' + 0D; // Component via DB15
Input6 := '~SH' + 0D; // HDMI
Input7 := '~SG' + 0D; // Computer2 RGB analog-RGB VGA
Input8 := '~SD' + 0D; // Computer2 DVI for Vivitek use
Input9 := '~SW' + 0D; // Wireless
```

**Use Code 2E code for projectors with ~S1 to ~S7 codes, Vivitek, D5500, D6000, D6500, D6510, Projection Display: DP3650**

```
Input1 := '~S1' + 0D; //Computer1 RGB analog-RGB VGA DSUB
Input2 := '~S2' + 0D; // RGBHV
Input3 := '~S5' + 0D; //Video1 Comp Video *(OPT1 swaps Video1 & Video2)
Input4 := '~S8' + 0D; //Video2 HDMI * *(OPT1 swaps Video1 & Video2)
```

\*T440: OPT6 switch ON will use S-Video in place of HDMI/DVI. T430: uses HDMI for Video2

```
Input4 := '~S6' + 0D; //Video2 S-Video *
Input5 := '~S4' + 0D; // Component via DB15
Input6 := '~S7' + 0D; // DVI-D
```

```

Input7 := '~S8' + 0D; // HDMI
Input8 := '~S3' + 0D; // WPC, Wireless

```

Any one of these codes can be set into Constant:0/Constant:1 for computer codes and Constant:2/Constant:3 for video codes. (The default is to have Computer1 (above) as the “Computer” channel and Video1 as the “Video” channel. Setting OPT1 switch ON will swap Video1 and Video2 channels, making S-Video the video default. Setting OPT5 will swap Computer1 and Computer2. Setting OPT4 will allow double- presses on some keyboards.).

- OPT7 handshake mode is NOT available;
- No 2-yellow-button mute is provided with a “Volume” keyboard as mute commands are toggle only;
- Power on panel connection blink codes are NOT available. There are no “blink” replies in standby;
- The audio control range has only 8 steps ... for finer resolution audio control, use a T441 or T461 audio controller. Smaller models don't have an audio output and only one audio input;
- You must turn off “Auto Source” and “Auto Power On” in “Installation II” menu;
- You must set “Standby Mode” to “Standard” (some only);
- You must turn off “Auto Power Off(min)” in “Installation II” menu, by setting to “0” minutes;
- On units with a “network” connection, you must ensure that the RS232 mode is selected for control. This is done in the “Installation II” sub-menu, then go to “Advanced”, press “Enter”, then go down to “RS232” and use the left/right buttons to select “RS232”. Use “Menu” to exit. (“Enter” does not work at this point.)

### Aspect ratio setting for Vivitek/Promethean family

The aspect ratio codes for all Vivitek/Promethean projectors are the same. Note that to use these, enable bits for ratios usable by each channel must be set into UserFlags[0..3] and the preselected or “default” aspect setting must be set into UserFlags[5..8] The functions provided are as follows:

	D940 etc	H1085	(AV3100) D5 Promethean 25 Spec 1.9	DP3630 Spec 1.6,0.03	S codes D5500 D6500,DP3650 0.02
SetAspect1	:= '~sA0' + 0D; // (same as ~sA1)	Auto	Fill	4:3	4:3
SetAspect2	:= '~sA1' + 0D; // Regular image	4:3	4:3	16:9	16:9
SetAspect3	:= '~sA2' + 0D; // Wide image	16:9	16:9		15:9
SetAspect4	:= '~sA3' + 0D; // Zoom	Letterbox	Letterbox		Crop
SetAspect5	:= '~sA4' + 0D; // Small 4:3	Real	Native		Letterbox
SetAspect6	:= '~sA5' + 0D; //				Native
SetAspect7	:= '~sA6' + 0D; //				Normal

(Note that aspect ratio commands are not accepted if there is no signal input to that channel.)

### Vivitek D5, D55, D75xx, D8, D86x, D9, X7 families (Code 2F ),

D54HA, D55BA, D86, D87,

D501ZAA, D501ZAA, D501ZWAA, D516, D517, D518, D519, D548, D550, D551, D552, D553, D554, D555, D556, D557, D557W, D557WH, D560ST,

D751ST, D755WT/i, D791ST, D795WT,

D837, D850, D851, D853W, D855ST, D856, D857WT, D858, D859, D860, D861, D862, D863, D864, D865W, D867, D869, D871ST, D873ST,

D910HD, D912HD, D965, D966HD, D967, D968U,

D5005, D5010, D5110W, D5180HD, D5185HD, D5010, D5190HD, D5280U, D5290U, D5380U, D7080HD, D7180,

H1180HD, H1185HD

(Message formats are ASCII with format: “VXXS0001<CR>” for Power On, “VXXS0201<CR>” for RGB select, etc. XX is “99” for global address for all projector address settings.)

RS232 formats for these are listed at: <http://www.vivitek.com.tw/upfile/down/2010-12-08/b20101208020945040.pdf>

Input1 := 'V99S0201' + 0D; //Computer1 Analog RGB 1 DB15  
 Input2 := 'V99S0202' + 0D; //Computer2 Analog RGB 2 DB15 (some only)  
 Input3 := 'V99S0204' + 0D; //Video1 Composite Video RCA\* \*(OPT1 swaps Video1 & Video2)  
 Input4 := 'V99S0206' + 0D; //Video2 HDMI 1\* \*(OPT1 swaps Video1 & Video2)

\* T440: OPT6 switch ON will use S-Video in place of HDMI/DVI. T430: Uses HDMI for Video2

Input4 := 'V99S0205' + 0D; // S-Video  
 Input5 := 'V99S0203' + 0D; // DVI  
 Input6 := 'V99S0205' + 0D; // S-Video  
 Input7 := 'V99S0207' + 0D; // BNC  
 Input8 := 'V99S0208' + 0D; // Component  
 Input9 := 'V99S0209' + 0D; // HDMI 2 / DP / Media  
 Input10 := 'V99S0210' + 0D; // HDMI 3 / DisplayPort (some)  
 Input11 := 'V99S0211' + 0D; // DisplayPort (some) / Multimedia (some)

Any one of these codes can be set into Constant:0/Constant:1 for computer codes and Constant:2/Constant:3 for video codes. (The default is to have Computer1 (above) as the “Computer” channel and Video1 as the “Video” channel. Setting OPT1 switch ON will swap Video1 and Video2 channels, making S-Video the video default. Setting OPT5 will swap Computer1 and Computer2. Setting OPT4 will allow double- presses on some keyboards.).

- OPT7 handshake mode is available;
- You must set “Standby Mode” to “Standard” (some only);
- Power off connection blink codes are available; (OPT7 projector state monitoring is also available);
- Turn off the “Auto-source” search feature in the “Setting” menu;
- Mute and Freeze are supported, and absolute mute via 2 Volume keys pressed is also available. Code A keyboards are thus supported;
- The audio control range has only 8 steps ... for finer resolution audio control, use a T441 or T461 audio controller.

### Aspect ratio setting for Vivitek D8 family

The aspect ratio codes for all Vivitek/Promethean projectors are the same. Note that to use these, enable bits for ratios usable by each channel must be set into UserFlags[0..3] and the preselected or “default” aspect setting must be set into UserFlags[5..8] The functions provided are as follows:

SetAspect1 := 'V99S03010' + 0D; // Fill  
 SetAspect2 := 'V99S03011' + 0D; // Regular video image 4:3  
 SetAspect3 := 'V99S03012' + 0D; // Video image 16:9

(Note that aspect ratio commands are not accepted if there is no signal input to that channel.)

### Vivitek, Barco, Digital Projection family with “op” style commands. (Note: no audio)

Vivitek: DP-9655NUHA, DP-9655NUHA, DP-9655NDPHA, DU6871/DW6851/DX6831, DU9000 (Code 4E , 9600 baud)

Barco: RLM-W, W6 series, RLM W8, Digital Projection: 8000 series (Code 4F , 38400 baud)

Barco: RLM W12, W14 series, Digital Projection: 7500 Series (Code 68 , 115200 baud)

(Message formats are ASCII with format: “op input.sel 2<CR>” for RGB select, etc.

RS232 formats for these are listed at:

[http://www.vivitek.eu/Files/ControlProtocols/DU6871\\_DW6851\\_DX6831%20Remote%20Communication%20Manual\\_EN\\_0522.pdf](http://www.vivitek.eu/Files/ControlProtocols/DU6871_DW6851_DX6831%20Remote%20Communication%20Manual_EN_0522.pdf)

<ftp://folsom.com/Products/Event%20Projection/03%20-%20Projectors/RLM-W/01%20-%20General%20Info/01%20-%20RS232%20Commands/RLM-W%20RS232%20codes.pdf>

[ftp://folsom.com/Products/Event%20Projection/03%20-%20Projectors/RLM-W/02%20-%20Software/W-12/SW\\_NP19/Barco%20RLMW12%20op%20command%20Rev1.3\\_%20120426.pdf](ftp://folsom.com/Products/Event%20Projection/03%20-%20Projectors/RLM-W/02%20-%20Software/W-12/SW_NP19/Barco%20RLMW12%20op%20command%20Rev1.3_%20120426.pdf)

[https://www.audiogeneral.com/barco/rlmw14\\_rs232.pdf](https://www.audiogeneral.com/barco/rlmw14_rs232.pdf)

<http://www.digitalprojection.co.uk/dpdownloads/User%20Guides/E-Vision%207500%20Series/E-Vision%207500%20Series%20User%20Manual.pdf>

<http://www.digitalprojection.co.uk/dpdownloads/User%20Guides/E-Vision%208000%20Series/E-Vision%208000%20Series%20User%20Guides.pdf>

```

Input1 := 'op input.sel 2' + 0D ; // Computer1 VGA DB15
Input2 := 'op input.sel 1' + 0D ; // Computer2 DVI or HDMI 2
Input3 := 'op input.sel 6' + 0D ; // Video1 Video (SDI on DU9000) *(OPT1 swaps Video1 & Video2)
Input4 := 'op input.sel 0' + 0D ; // Video2 HDMI (or HDMI 1 on DU9000) *(OPT1 swaps Video1 & Video2)
* T440: OPT6 switch ON will use S-Video (or HDBaseT) in place of HDMI/DVI. T430: Uses HDMI for Video2
Input4 := 'op input.sel 5' + 0D ; // Video2 S-Video (or HDBaseT on DU6871, DW6851, DX6831) *

Input5 := 'op input.sel 3' + 0D; // Component 1
Input6 := 'op input.sel 4' + 0D; // Component 2 (or DisplayPort on DU6871, DW6851, DX6831)

Input7 := 'op input.sel 7' + 0D; // HDBaseT on DP9655
Input8 := 'op input.sel 8' + 0D; // Barco SDI/HDSDI/3G
Input9 := 'op input.sel 9' + 0D; // Barco STEREO DVI

```

Any one of these codes can be set into Constant:0/Constant:1 for computer codes and Constant:2/Constant:3 for video codes. (The default is to have Computer1 (above) as the “Computer” channel and Video1 as the “Video” channel. Setting OPT1 switch ON will swap Video1 and Video2 channels, making S-Video the video default. Setting OPT5 will swap Computer1 and Computer2. Setting OPT4 will allow double- presses on some keyboards.).

- OPT7 handshake mode is NOT available;
- You must set “Standby Mode” to “Standard” (some only);.
- Power off connection blink codes are available;
- Turn off the “Auto-source” search feature in the “Setting” menu;
- Mute and Freeze are NOT supported
- Audio is not supported.

### RS232 connections to Vivitek and Promethean (not verified for “op” series)

These use a 9-pin-D9 male on the panel, female on cable. Comms is at 9600 baud, 8 N1.

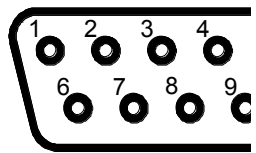
Function/Direction	T440 “projector” Connection	“Serial” Port Connector	 <p>D-sub 9 female</p>
Ground	Ground	9-pin D-sub pin 5	
Data from T440 to projector	Tx	9-pin D-sub pin 2 (RXD)	
Reply data from projector to T440	Rx	9-pin D-sub pin 3 (TXD)	
Plus 9 volt CTS/DTR to projector	n/c	n/c	

After installation wiring of any projector to a T440, use a multimeter to check voltages of –9 on BOTH TX and RX pins in any installation, as described in the troubleshooting part of this manual.